

# The principles of inertia and reaction revised and corrected by SPAWHE.eu against thermal, nuclear and electric car follies.

The simple and economical way to produce energy, purify and distribute the world's water

## Abstract

The first to study the principle of inertia was Galileo (1564 -1642), who stated that a body will continue to move in uniform rectilinear motion, or will remain still, if it is not subject to external forces. Even today, many who teach the principle of inertia fail to say that Galileo was referring to the movement of bodies in the empty space of the universe, where there is no friction with the atmospheric air surrounding the Earth. The same gravitational force would deviate space bodies toward the Earth as it deviates the air molecules that form the Earth's atmosphere. In fact, Galileo was the first to discover the gravitational force and its value of  $9.81 \text{ m/s}^2$ , which condenses atmospheric air to the pressure of one atmosphere. Therefore, he could not forget the resistance to motion of atmospheric air. The value of atmospheric pressure was measured for the first time with a special invention by his disciple, Evangelista Torricelli (1608 – 1647), who with a glass tube and a basin filled with mercury demonstrated that atmospheric pressure raised the mercury in the glass tube by 760 mm. Later, he also formulated Torricelli's law which states that the speed of a fluid exiting from a hole (with a very small section compared to the dimensions of the container) is equal to the square root of

the double product of the acceleration of gravity and the distance "h" between the free surface of the fluid and the center of the hole that has been made. This demonstrates that the value of the acceleration of terrestrial gravity of 9.81 m/s<sup>2</sup> was already known when Newton (1642 – 1726) legislated that a mass of one kilogram, in proximity to the earth's surface, undergoes an acceleration of approximately 9.81 m/s<sup>2</sup>. In fact,  $1 \text{ kg}_{\text{peso}} = 9,81 \text{ N}$  in honor of Newton. So, Galileo and Newton are respectively the discoverer and the legislature of the gravitational force, while Torricelli is the inventor and experimenter. So, the principle of inertia is valid for bodies without their own energy subject to the forces of the universe. The current environmental problems on Earth began when man tried to energize terrestrial bodies to better organize human work for the purposes of heating, cooling, movement on land, in the sea, in the atmosphere, working the land and more recently, also to fly in the atmosphere and in space. Men had several options to extract energy from the environment, but unfortunately, they chose the worst ones from a climatic point of view, but also economically, without taking into account that the Earth took 4.5 billion years to completely free itself of atmospheric gases, born with nuclear explosions and the formation of the Earth. To then slowly cool down to the pre-industrial temperature of the late 1800s. When they started to warm the planet again with the first thermodynamic inventions with steam boilers, steam trains, steam cars and then with heat engines and nuclear power plants. They completely neglected the publications of scientists that have not changed, which could clarify our ideas on the movement of cold fluids published before the industrial development, which, today, integrated with the inventions reported on the website <https://www.spawhe.eu>, they could have coldly powered bodies, simply extracting energy from the Earth's environment, with immense economic and environmental benefits for all humanity. The second and third laws of dynamics, called reaction laws, published by Newton,

are undoubtedly fluid dynamics. Hidden interests and great scientific incompetence of the ruling classes from the end of the nineteenth century to the present day, have led to the continuation of the thermodynamic choice as the cornerstone of the world economy, aggravated by the scientific and economic nuclear follies being tested in Europe. My almost twenty-year experience as an inventor has been characterized mainly by the revaluation of the scientific organization of work learned in my almost twenty-year experience as an installer of systems in the automotive industry, which is the best organized industry in the world in terms of productivity; and in the revaluation of the fluid dynamic principles which, in my opinion, have been the most undervalued scientific principles, in my almost twenty-year activity as an installer of environmental and water lifting systems, installing these types of systems in Italy and Tunisia, as shown by <http://www.spawhe.eu/english-curriculum-vitae/>.

It would be enough to remember that in the International System the unit of measurement for work is the joule which corresponds to the displacement of one meter by a force of one newton:  $1 \text{ N m}$

The kilogrammeter is the work necessary to lift a mass of one kilogram by one meter, considering an average acceleration of gravity on the ground equal to about  $9.81 \text{ N m}$

The electronvolt is the work performed by an electron to cross a potential difference equal to 1 Volt. This means that the tension creates the pressure that pushes the electrons in a single direction, as happens in fluid dynamics. While in thermodynamics and nuclear power, heat and radiation expand in all directions, together with fumes, combustion gases, steam. How is it possible to control and even breathe energy? In fact, even if no one believes it, Spawhe's energy is the only one that can take man into space.

## **1. On planet Earth, fluid dynamics must replace thermodynamics**

From the summary above, anyone with a minimum of scientific and technological knowledge should understand that there is a greater affinity between fluid dynamics and electromagnetism than the current connection between thermodynamics and electromagnetism, as we are not talking about calories but about masses and elementary particles of water and atmospheric air that interact with the natural ionic exchange between the Earth's surface, the ionosphere and the hydroelectric system. Not the current hydroelectric system, but the one developed by the undersigned virtually, without public and private money and without the hydraulic jump, at atmospheric pressure, or compressed, for mobile systems, or those that need to be compacted to produce greater electrical power than the volume occupied, such as in wells, domestic environments, means of transport, even artificial hearts. These plants, although they were born in 2014 – 2015, in the basic versions and subsequently developed in the various fixed and mobile versions, do not yet exist, while they could be everywhere, replacing the current electricity distribution networks, especially, in high voltage (which interferes with the natural ion exchange with the ionosphere, mentioned above) because electricity can be produced locally in fixed and mobile plants without transporting it and without transformation cabins. As we are seeing in the current wars in Ukraine and in the Gaza Strip, electricity is the first to be missing just when people need it most, being produced remotely, moreover, with very high costs, while it could be extracted locally from the earth's environment with totally recycled water and air, which cost nothing. Atmospheric air, by the grace of GOD, already surrounds the planet, while water with the SPAWHE system, should be distributed without pressure throughout the planet, to use it when needed for civil, industrial purposes and to extract hydroelectric energy from it without the hydraulic

jump. It is against nature to accumulate water in mountain valleys that serve to slow down the flow of rainwater, while today, to produce electricity with the hydraulic jump we fill the basins and increase the danger of floods and even the collapse of dams.

However, this very serious design error can be remedied by transforming hydroelectric plants with the hydraulic jump into hydroelectric plants without the hydraulic jump that can produce hydroelectric energy with infinitely recycled water while keeping the basins empty to accumulate water without producing floods, as proposed by the undersigned on the occasion of the disaster at the Bargi power plant in Italy on

**20.04.2024**

**<https://www.spawhe.eu/lets-talk-scientifically-about-the-italian-disaster-of-the-bargi-hydroelectric-power-plant/>**

LAGO BRASIMONE

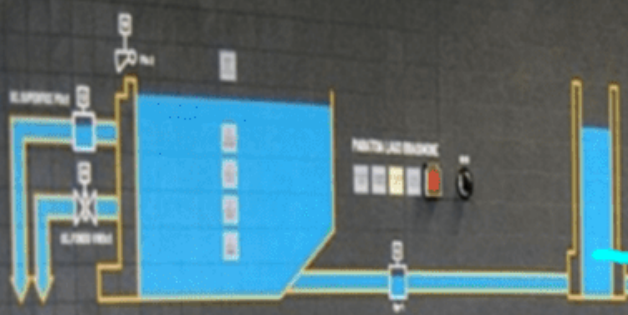

CENTRALE SIRMIONE

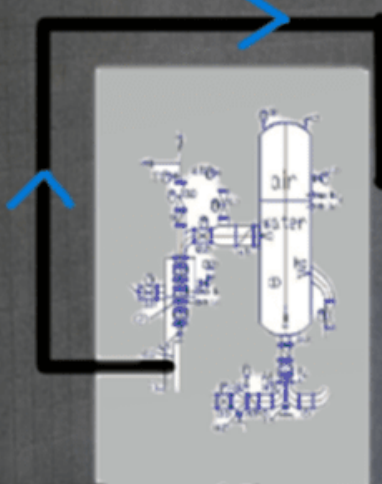

pompa con motore  
 pump with motor  
 Turbina con alternatore  
 turbine with alternator

V<sup>2</sup>/2g  
 serbatoio chiuso di scarico alla pressione atmosferica  
 closed waste tank at atmospheric pressure

GENERATORE DI CORRENTE IDROELETTRICA COMPRESSA

COMPRESSED HYDROELECTRIC GENERATOR

LAGO SIRMIONE

overturned pump with dual supply (opds)

pompa capovolta con doppia alimentazione

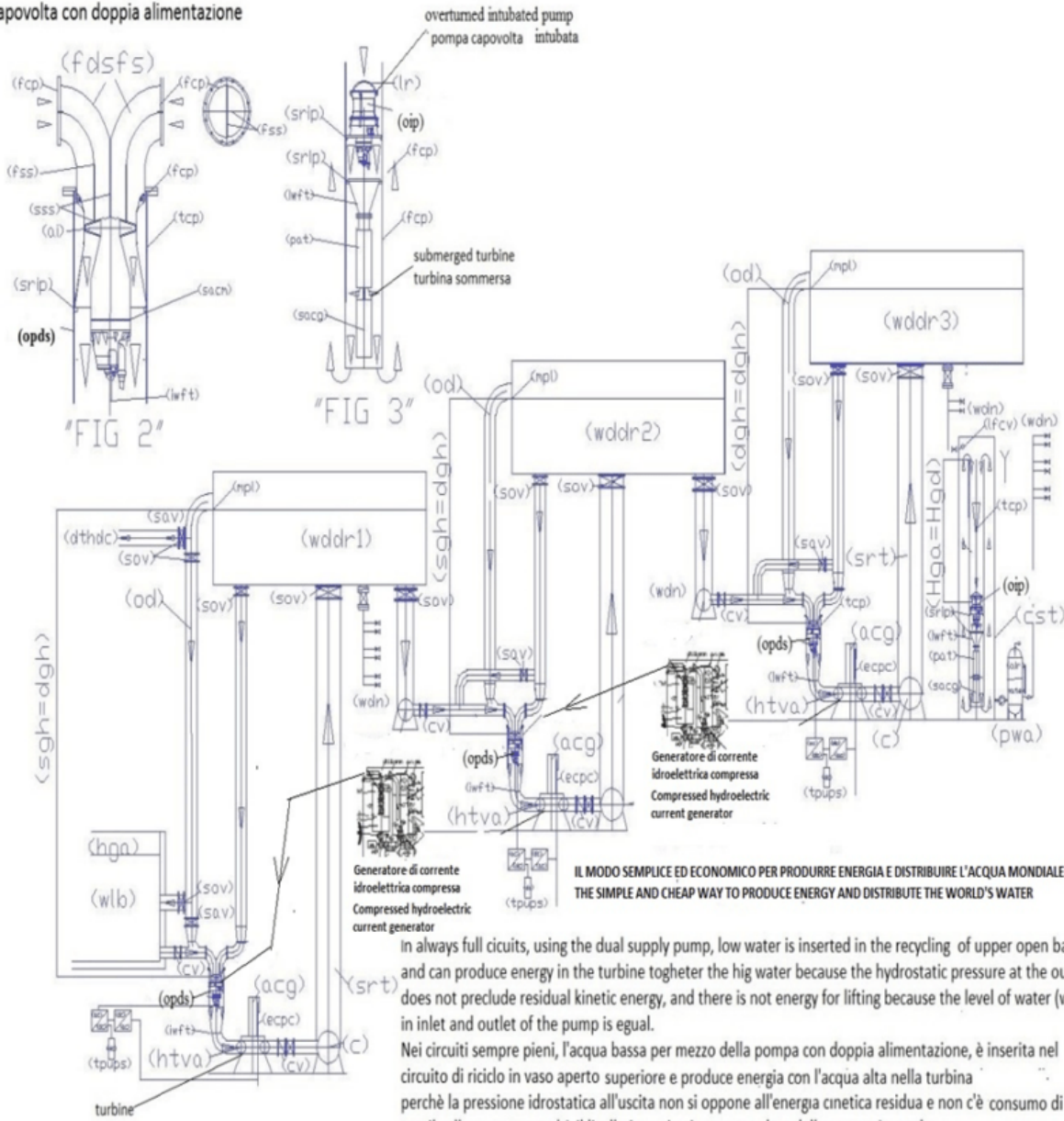

Sistema di sollevamento idroelettrico a gradini sommerso rinforzato con sistema idroelettrico compresso  
 Reinforced submersed stepped hydroelectric lift system with compressed hydroelectric system

So, the world's large hydroelectric plants are wrong, but they can be remedied, and the world's large thermal plants are also wrong, and they can be remedied. The current means of transport with thermal engines are wrong. If we can extract cold hydroelectric energy in mobile versions with compressed hydroelectric, even more so, we don't even need electric cars that need to be charged with electricity distribution networks. Even less is nuclear energy needed. So, I am sorry

to say that scientists who continue to propose nuclear power should change their profession. But those who oppose nuclear power by proposing simple renewable energies that have no potential to satisfy the planet's energy needs should also change their profession. I am referring to powerful associations such as Greenpeace that in articles such as the following

<https://www.greenpeace.org/italy/cosa-facciamo/nucleare/> they report the problems by writing words like the following: **The fact that it has proved to be an economic failure both in France and in the United States should be enough to dissuade us from returning to nuclear power.** The costs of the French plant in Flamanville have risen to 19.1 billion euros (instead of the estimated 3.3 billion), while two of the four reactors under construction in the USA have been cancelled and the other two are continuing at exorbitant costs: from around 9 billion dollars they have already gone down to an estimate of around 32 billion. Things didn't go any better for the two reactors in Hinkley Point, in Great Britain, which were supposed to cost 18 billion pounds and are now estimated at 46 billion. Even for associations like Greenpeace, the Spawhe system doesn't exist. They also ask me for donations like they ask everyone else. To do what? Where are their solutions?

We are at year zero of terrestrial and spatial development because since the beginning of industrial development there has been an evident forcing to privilege thermodynamics over fluid dynamics in global economic development. The easy profits allowed by fossil fuels have penalized the scientific and technological development of fluid dynamics, which if it had developed terrestrial energy coldly, as planned by the Creator of the universe, without this evident manipulation, certainly, today we would live in a better, cleaner, cheaper and more sustainable world, without giving up current technological comforts. With the only obvious difference that there would be fewer poor people in the world, fewer migrants. Probably, we would not have had the first and second world



wars. Above all, we would not find ourselves on the threshold of the third world war, as we are currently, with the war in Ukraine, in the Gaza Strip, the revolution in Syria and many other hotbeds of senseless wars. Which would have no reason to exist, if science, justice, medicine had been above the parties, as it should be on a small planet, which compared to the size of the universe, is little more than a grain of sand. The immense selfishness of men in power, who are afraid of losing their privileges, acquired illegally through barbarian invasions, of the Romans and those that followed, who instead of exchanging scientific knowledge and culture are still competing to design weapons of destruction of men and the planet itself.

Planet Earth at the end of the nineteenth century was fortunate to have great geniuses such as Einstein, Tesla, Ferraris, Edison, who very strangely, concentrated on electrical phenomena, never questioning the primary source of world energy, which for them was thermodynamic, as it came from the nuclei of stars and planets. But the most interesting phenomena can be noted above all, in electromagnetism, thanks to scientists such as Hans Christian Oersted (1777-1855), Andre Marie Ampere (1775-1836), Michael Faraday (1791-1867), William Thomson (Lord Kelvin, 1824-1907), James Clerk Maxwell (1831-1879), and finally Hendrik Lorentz (1853 – 1928) who, by deepening his work, identified what is commonly called the Lorentz force.

The formula that allows us to calculate the force in Newtons is the following:

$F = qv \times B$ , where  $qv$  is the quantity of motion (mass times velocity) and  $B$  is the intensity of the magnetic field.

The direction of this force follows the right-hand rule by placing the thumb in the direction of  $qv$ ,

the index finger in the direction of  $B$ , while the middle

finger indicates the direction of the force.

When these directions are not perpendicular to each other, the formula becomes

$F = qv \times B \sin$  adjacent angle. In the case of a centrifugal force we have:  $m \times v^2/r$

The Lorentz force applies not only to particles moving in the magnetic field but also to the sign of the charge. If the sign of the charge is reversed, the direction of the force is also reversed.

With the use of thermodynamics instead of fluid dynamics, the Lorentz force has been penalized more than anyone else, it seems that no scientist has noticed the damage suffered by planet Earth, including Lorentz himself. In fact, on planet Earth the electromagnetic push can only be achieved cold, requiring the circulation of permanent magnets and coils of thin copper wires protected with insulating paints, not suitable for working in the presence of heat sources. Furthermore, planet Earth is an environment surrounded by gravitational force, communicating with the universe through the filtration of the Earth's atmosphere that protects it from cosmic radiation.

The Earth's climate is thermoregulated by the ion exchange between the Earth's surface and the ionosphere and worked almost perfectly until man began to produce fossil energy in thermal power plants, steam with nuclear power, solar panels and to transport energy at high voltage on pylons which are all elements that interfere heavily with the natural ion exchange between the Earth's surface and the ionosphere.

The Earth's surface and the ionosphere behave like the armatures of a large capacitor that produces the right amount of electrical discharges through lightning and therefore the right ionization of the water in the air that regulate the biological life of the planet through the four seasons. With

the production of thermal and nuclear fossil energy, solar panels and the transport of high voltage energy on aerial pylons we have upset all the electrostatic balances of the planet and the ionic exchange between the Earth's surface and the ionosphere no longer works.

I, as a designer and installer of industrial and then environmental plants, understood that on planet Earth we had to close all the thermal, chemical and biological cycles that we opened in anthropic plants and therefore, as soon as I had the opportunity to retire (in 2006) I started producing inventions that go in that direction. Unfortunately, no one believed me and none of my inventions were realized. But as I wrote above, my inventions would be particularly useful also in air-space and submarine transport, where the environments are completely closed and all the cycles, not only must be closed, but also completely regenerated to ensure the survival of human beings. Therefore, the ideal energy for going into space is an energy produced at the temperature and pressure of the Earth (natural or artificial) breathable by human beings, extracted from incompressible and ionizable water and from compressible and equally ionizable air. Both elements are infinitely recyclable and can be produced and regenerated even in space with artificial light, chlorophyll photosynthesis and the carbon cycle, bringing the elements necessary for human nutrition into space transport vehicles. They too are infinitely regenerable. It is no coincidence that my artificial human heart (ignored by terrestrial science) works on the same principles for blood circulation and oxygenation, but without the Newtonian and Lorentzian thrust. While the linear motors outside the space cars need Newtonian thrust to exit the atmosphere and Lorentzian thrust to move in space. Obviously the air vents necessary for electrical and electromagnetic production are conveyed into the transport cars, pressurized to terrestrial pressure, as described in the appropriate publications.

According to the most enlightened scientists in the world, even the energy from the universe follows the same rules: the sum of the energy produced and consumed is equal to zero, but since the spaces are infinite, the problems of pollution from local heating and cooling have no importance.

The planet Earth can be considered as a large space wagon, contained in a space delimited by the Earth's atmosphere, which travels in the universe. The amount of energy that it can dissipate in space has already been determined in four and a half billion years because our atmosphere cannot dissipate more without serious climate changes. Exactly like the space wagons conceived by the undersigned, which must recycle all the water, air and organic waste produced with their power in order to survive, being able to draw from artificial light, photosynthesis, interstellar dust only a small part of the elements necessary for the survival of space crews and their families.

Paradoxically, planet Earth, in order to dispose of greater quantities of heat produced by nuclear thermal energy, should be equipped with a greater quantity of atmospheric air and gravitational force for cooling. But this is a contradiction because on planet Earth they have the possibility of coldly extracting energy from the environment without producing CO<sub>2</sub> and steam and without having to transport energy over distances, producing and consuming it locally without interfering with the natural functioning of the Earth's climate control, which is precisely the ion exchange between the Earth's surface and the ionosphere.

Therefore, the space race cannot be conceived as a tourist trip around the Earth that must be finished before the fuels run out. It must be conceived as an autonomous exodus without return for energy and food survival with a long series of containers specialized in food production and spare parts connected to each other smaller space vehicles as described in the following article.

**07.29.2021**<https://www.spawhe.eu/from-the-earth-beyond-the-moon-colonizing-space-with-compressed-hydroelectromagnetic-energy-unknown-to-terrestrial-science/>\_

Unfortunately, we humans are destroying ourselves because of human inventions, which, by not respecting the rules established by the creator of the universe, are destroying the planet we live on, and consequently also human beings. Governments and in particular the United Nations Organization are not showing themselves to be up to the situation. This is above all a political body of mediation, instead it should be a great center of experimentation of global development so that all people live with the same level of scientific technology and social well-being. Faced with this great global institutional absence, I as a small inventor of solutions of public social utility, not seeing any of my forty inventions accepted and tested and tired of continuing to propose inventions, I have proposed to create a large joint stock company to test all inventions, not only those of those who have economic power, as described in the following article published on **28.02.2020** <http://www.spawhe.eu/a-global-stock-company-against-errors-omissions-and-opportunities-wasted-by-science-and-world-power-centers/>

Having found no interlocutors in the following years, I turned to the Non-profit sector, as described in the following article of **27.11.2021** <https://www.spawhe.eu/fundraising-in-defense-of-life-according-to-the-spawhe-model/>

The Non-profit did not work. Although I turned to expert companies such as “Gofundme” and Fiver, I did not raise even a single euro. These problems must be solved by governments and the United Nations.

The current world ruling class did not even finance the hydroelectric car that would extract energy from the Earth’s

environment, preferring simply electric ones that must be charged from the electricity grid produced by thermal power plants.

Unfortunately, the previous inventions on the cleaning of fossil energy, from which the subsequent inventions described in the SPAWHE nursery rhyme (reported below) were born, have also remained in a virtual state due to the incompressible, silent resistance of the entire political, entrepreneurial, cultural, trade union, etc. class.

Therefore, the SPAWHE system, officially, does not exist, neither for the powerful of the Earth, nor for the poor and defenseless, nor for the intermediate classes

## **2.Global warming can be stopped by globally designing human-made terrestrial systems**

**I would like to share the following quote from Charles Bukowski: "I have no more time to waste on people who think they are superior or chosen. I have no more time or desire to justify who I am. I have no more time for false people. I have no more time for anything that has no soul. I have no more time to waste!" On June 6, 2024, I turned 75 and I believe that global warming can be stopped.**

**Existing technologies are already sufficient. All that is missing are those that integrate the SPAWHE system that the current ruling class pretends not to understand. On this occasion I also publish the IBAN of a current account of the Ing Bank, registered to the undersigned, which is currently empty, so that it can be filled by competent people. Not to do charity, but investments with honest profits, certainly higher than current profits, as the SPAWHE system has the potential to renew the entire world economy. The IBAN is the following: IT78I0347501605CC0012826539. The objective is the following: The creation of SPAWHE SPA, which aims to experiment and realize all the inventions of SPAWHE. The risk of losing the**

capital by the investors is zero. Because in the event that, within a year, the fundraising is not sufficient to set up the company and start the business, the capital raised will be returned to the individual financiers. In fact, the following reason must be indicated in the bank transfer: SPAWHE SPA company formation. In the intentions of the undersigned, SPAWHE SPA will be a multi-disciplinary joint stock company for the design, testing and construction of fixed and mobile anthropic energy and purification plants. SPAWHE SPA will legally claim the intellectual property of all forty inventions of the undersigned, which are not yet funded by any public or private body in the world. These inventions have not been funded and tested, although they all have the requirement of public social utility.

The undersigned is not interested in industrial property, he claims intellectual property because the SPAWHE system can be considered a single great invention developed from 2006 to 2024, where everything is interactively connected with water and air purification systems that interface through forty inventions, regularly filed in Italy. Of these, twenty-seven have received the industrial patent title, one has received the European patent, five the international patent, the others, probably the most important, have not received any patent, because they have been accused of wanting to create perpetual motion by the Italian and European patent offices, which have shown their incompetence in matters of the environment and energy, as I have demonstrated that with my inventions I could also go into space without fuel.

If I am recognized as having intellectual property, it will not go to me, but to SPAWHE SPA, because I have no capital to pay because I have not earned even one euro from my activity as an inventor. I have only spent about 20,000 euros to pay the patent filing fees. If I had also paid the patent maintenance fees, I would have starved to death along with my family.

My energetically autonomous artificial heart would also work on the same principle of clean energy extracted directly from the environment. By oxygenating the blood in both the systemic and pulmonary circuits by means of two tiny autoclaves containing slightly compressed air, it could allow the extension of human life beyond all expectations.



## ARTIFICIAL HEART OXYGENATOR OF BLOOD, ENERGETICALLY AUTONOMOUS.

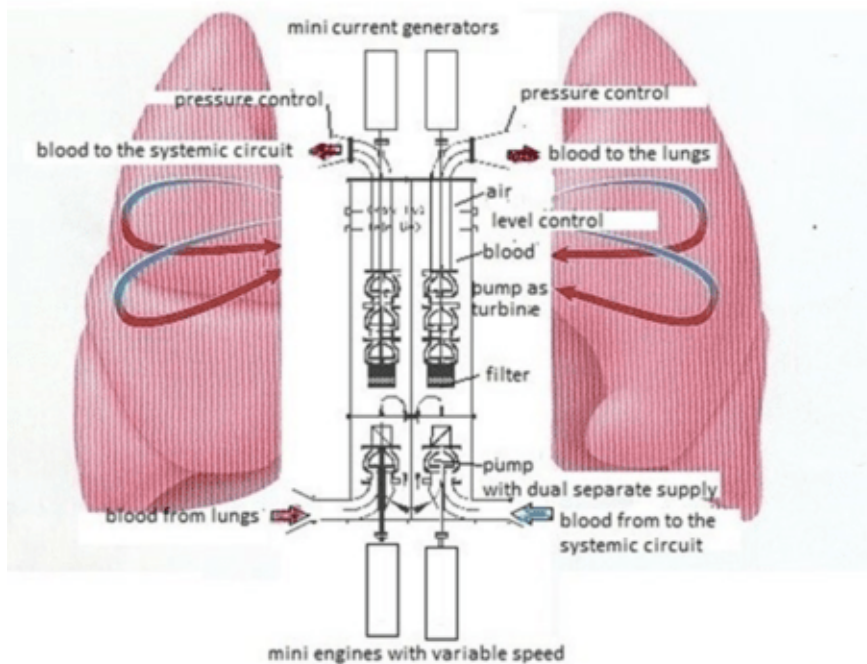

The artificial heart of man, proposed in this patent deposit, closes the circle of sustainable energy based on the only physical principle possible in every remote corner of the Earth: the bypass of the force of gravity and of the elastic pressure of the air that it can be realized everywhere, even in the man's chest, using pumps with the double supply separated until to the impeller, which science, industrialists and world legislators pretend to ignore in order not to admit that they have wronged the entire industrial and economic development. Everything would have been simpler, cleaner and cheaper if this invention had taken place a hundred years earlier, as it could have been. The artificial human heart is the miniaturized version of the autoclave system, already reduced, to make it enter the wells' shirts, to purify the water producing energy. Entering the chest of the man to purify the blood producing the energy needed by the brain is not much different from expected for the wells. They serve two mini parallel autoclave systems that replace the right and left atria ventricles. The two pumps that feed them, with the double supply separated until to the impeller, allowing the balance of the hydrostatic thrust in suction and delivery, allow to get the blood coming from the systemic circulation in the mini autoclave on the right and the one coming from the lungs in that left, bypassing the compressed air pressure. This system works autonomously because the mini autoclave ejects at the same instant the quantity of blood equal to the one that enters, due to the principle of impenetrability of the bodies, through a mini pump used as a turbine connected to a direct current generator. The energy spent by the pump motor is about a tenth of the energy produced by the generator. This allows us to have enough energy available to produce the amount of compressed air necessary to the autoclave and the management of an electronic control unit that with a three-word voice command: "rest, normal, fast" manages the flow and the blood pressure according to the physical activity that it carries out. Although it is the air pressure that circulates the blood in the pump used as a turbine, since the circulation is one-way, apart from air solubilized in the blood with purifying effects, there is no other consumption of compressed air because it is exploited statically and not even electricity to produce it. Although it is the air pressure that circulates the blood in the pump used as a turbine, since the circulation is one-way, apart from the solubilized air in the blood with purifying effects, there is no other consumption of compressed air and electric energy. As published on <http://www.spawhe.eu>, this solution was found by myself after many years spent trying to improve the purification systems of water and air and many patents filed in vain. However, the study served to ascertain that world science has identified single and incomplete scientific principles, which used singly have polluted and warmed the planet. Only with the invention of the pumps with the double power supply separated to the impeller, the undersigned has found the key of the problem. In fact, through it, the dynamic fluid used cold between water and air, especially compressed, would have produced energy protecting the environment, consuming only moderate wear of materials, with low operating temperatures, and air pressures used statically, which would circulate the incompressible liquid. This is the true principle of terrestrial energy that, unfortunately, has not been legislated by world science, which still ignores it, hoping that in addition to myself, no one notices it. Too late. They would have to admit their mistakes, before this energy, despite their silences, also entered the human heart, were, not only it can extend the life of man for many years. But when the other organs are too old, the brain system and the artificial heart. It may also be transferred into an artificial body, which we now call robots, but governed by the human brain and the accumulated knowledge throughout life that will continue to grow even after the death of the body. Reality can overcome fantasy because in no science fiction film this form of human survival has been hypothesized. If the human soul exists it is contained in the brain and its knowledge. It will not be humiliating for anyone to survive thanks to an artificial heart, cybernetic, and some syrup specially designed by nutritionists to be solubilized in small autoclaves that will replace the ventricular atria. When we are ready to do this. We will also be ready to conquer the infinite space. Not before. With our very short current life, we cannot go very far. (<http://www.spawhe.eu/artificial-heart-oxygenator-of-blood-energetically-autonomous/>).

For these reasons, I believe that the undersigned is entitled by right to the intellectual property that is granted to all works of art even if they do not file patents and do not pay taxes. The duration of the intellectual property right is 70 years after the death of the author. The Copyright Law states that the following works are protected, for example:

.. literary, dramatic, scientific, didactic, religious works, whether in written or oral form;

.. musical works and compositions, with or without words;

.. choreographic and pantomimic works, of which the outline is fixed in writing or otherwise;

.. drawings and works of architecture;

.. works of cinematographic art, silent or sound, provided that they are not simple protected documentation;

.. databases understood as collections of works, data or other independent elements systematically or methodically arranged and individually accessible by electronic means or otherwise.

The SPAWHE system is certainly not inferior to the works listed above. The logic of the SPAWHE system could not be understood until all the inventions were connected to each other. In fact, the current ruling class has not financed even one of them and the planet Earth is overheating, losing out economically, not only for energy costs, but also for the damage caused by floods, cloudbursts, droughts, fires. The latter cannot be put out because it would be necessary to stop in a stable way on the fires. Only by coldly adding together the thrust of Newton and Lorentz could this happen, but the boycott of SPAWHE inventions does not even allow this, just as it does not even allow the rescue of shipwrecked people at sea. How can one think that man can go into space if he cannot even add the thrust of Newton and Lorentz in the Earth's atmosphere?

In SPAWHE solutions it is not heat that produces electricity but pressure and the speed of water. With air included as an energy source and water as an energy vector. Therefore, we can produce energy even at the poles and in the deserts without fuels and heat always with the same water and air in an open circuit only at the exit of the hydraulic turbine, where the residual pressure is discharged to atmospheric pressure, while at the same time we introduce the same amount of water into the pressurized recycling hydraulic circuit, connected to the autoclave by means of the single-impeller centrifugal pump with the double separate power supply up to the impeller, which I have not physically built due to lack of funding, but I am 100% sure of its operation because I know how pumps work, almost like the pump manufacturers, who, strangely, have never spoken about my invention, nor have they made me proposals for collaboration for experiments. Evidently, even the pump manufacturers prefer the current market, where pumps absorb energy instead of collaborating in production. I do not understand their silence. However, for me the centrifugal pump with the double separate power supply up to the impeller is one of the most important inventions of all time and I am proud to have invented it. For this reason I spent the last 3500 euros for the international patent filing, which however did not help to find public and private financiers. However, this did not stop me and despite the lack of investors, I used the modified pump in all subsequent environmental, energy, terrestrial and space inventions.

Of course, limiting myself to filing intellectual patents, not industrial ones, even if current legislators do not grant intellectual patents to inventors. As written above, they grant them to literary works and musical compositions.

### Flying container for the rescue of migrants with Newton and Lorentz thrust without fuel

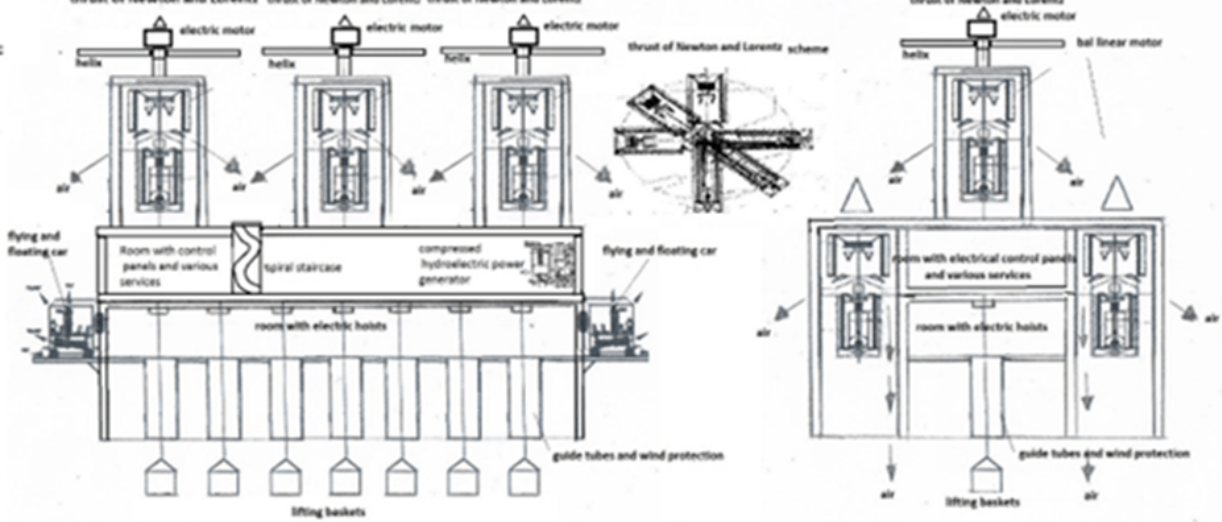

### Firefighting flying container with Newton and Lorentz thrust without fuels

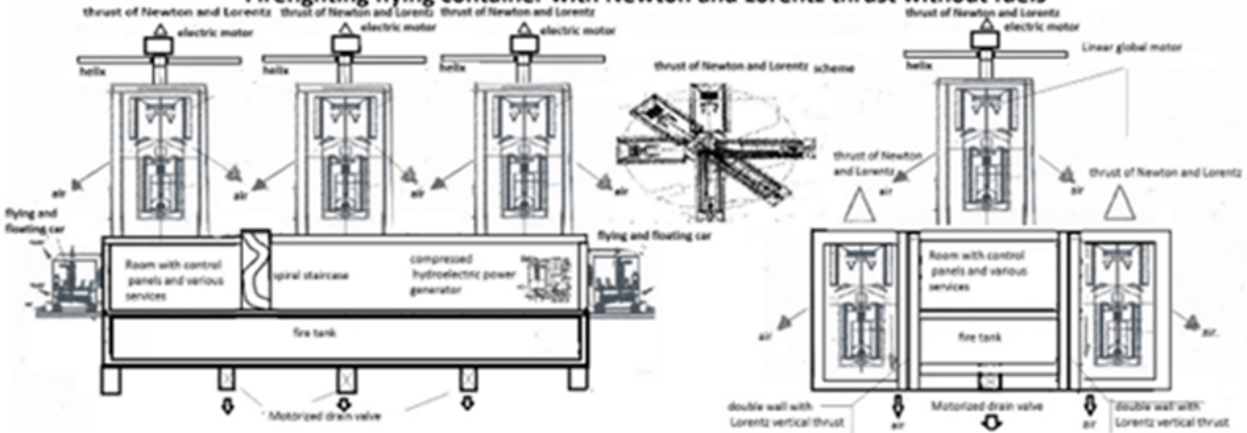

The solutions reported above seem like science fiction and they are. But if it was possible for me to think of them, it is due to the invention of compressed hydroelectricity and the pump with the double separate power supply up to the impeller. On planet Earth we have two immense sources of clean energy which are water and atmospheric air, which with the compressed hydroelectric system could power all terrestrial means of transport and work and even take us into space.

Probably, with fire-fighting containers full of water, we could also go into the ionosphere area above the deserts to trigger rains and fight desertification. We will never know if we do not free ourselves from the current way of designing anthropic plants that does not take into account the real climatic functioning of planet Earth.

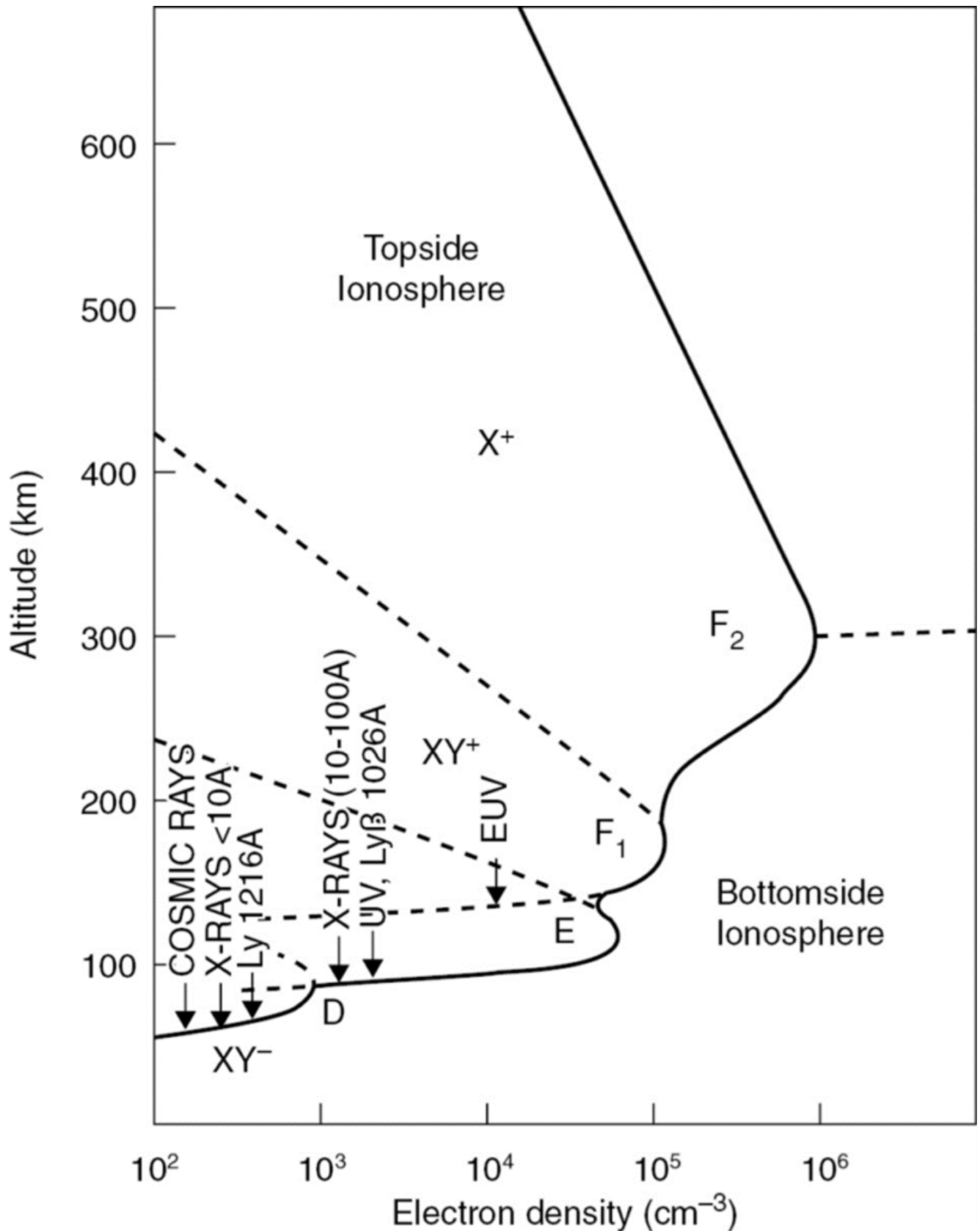

These inventions are held back by a global ruling class that wants to continue selling oil and at the same time use artificial intelligence only where it is possible to make easy economic gains without working, with stock market speculation. In fact, with artificial intelligence it is easier to identify

companies that grow and those that do not grow, especially because it is the large capitals that allow these power games. Unions and the entire world population do not interfere in scientific and technological matters. Science is made up of public employees and multinationals who must obey their employers. The one-way trade of public patents towards multinationals prevents the creation of truly alternative inventions to the current world power centers. These are the real reasons why none of the forty inventions of SPAWHE have ever been financed and tested. With global warming, damage to the environment and to the production system, especially food, is multiplying. The costs of repairing the damage due to climate change are multiplying because repairs do not last long against a system that is fundamentally wrong. If we do not start immediately to change the world's water distribution and from this extract coldly, in a simple, clean and economic way the entire world energy without dispersing the world's drinking water, as is currently happening, climate change will continue to destroy the planet and the entire world economy without anyone opposing it because everyone, directly or indirectly, works for those who currently hold the world's economic power. It was no coincidence that the undersigned had to wait for retirement to develop his own solutions. It was no coincidence that they were not taken into consideration. It is no coincidence that inventors are not recognized as having intellectual property. It is no coincidence that inventors are asked to pay annual industrial patent maintenance fees even if they do not find financiers. It is no coincidence that no multinational puts the synergy between global anthropic plants at the forefront, being specialized in single sectors. No one has ever proposed artificial welling as a food source.

## ARTIFICIAL WELLING

THE INTERACTIVE SYSTEM TO COMBAT ACIDIFICATION OF OCEANS PRODUCING DISSALATIONS, ENERGY, FOOD AND WORK.

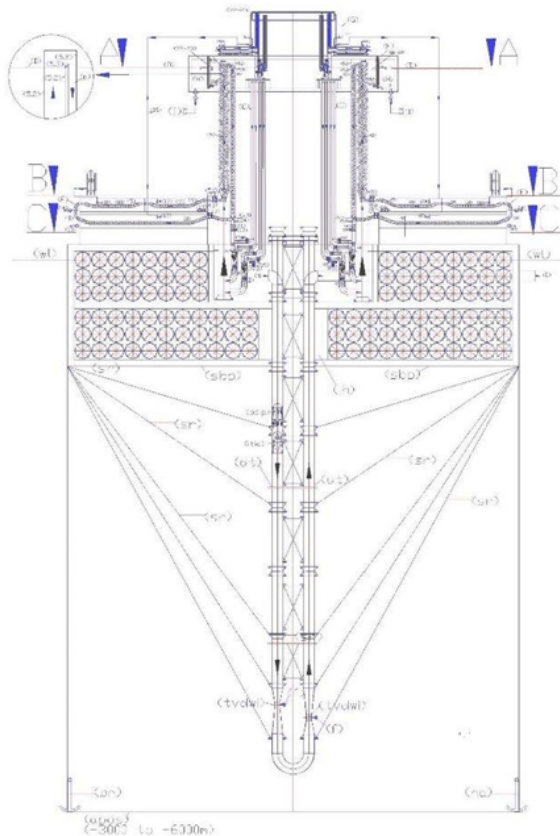

The state of the art in the development of desalination and demineralization treatment of marine and brackish water has been affected, along with industrial systems, purification, energy, food and protective of the environment, the absence of synergies between the pumps and hydraulic turbines and from the incorrect approach with the gravitational force, which must not be won by the hydraulic lifting but sustained, with one-way movement of water, especially in the gravitational direction, in the sea, in large basins, in open tanks. With simply overturned pumps coupled to the turbines can produce low-cost all the energy you need; continuing the descent and ascent of water in deep waters, for the venturi effect, we can suck and lift small percentages of deep water with high calcium and carbon percentage solubilized in them, that arrived at the surface, producing phytoplankton and alkalinity, increasing the abundance of fish and combating acidification and global warming; while on the floating platform, made with extruded and ribbed tubes made of low density polyethylene, blown in them polystyrene foam to make them unsinkable, with the triple synergy between the dual fuel pumps, turbines and the marine water recycling, by applying known hydraulic principles for centuries, as that of communicating vessels, the laws of Bernoulli and Pascal, placing, strategically, the electric double suction pump between a high positive hydraulic head and the turbines, we can desalinate large quantities of water, simply transforming a vertical tube in a ionic exchanger and recycling pipes and mixing in the energy producers, while the anionic and cationic synthetic resins, circulating contained in perforated polyethylene spheres as sieves. These spheres, floating climbing ion exchanger and descend for gravity emptying water in downhill tubes. By means of diverters change the path compared to the flow to be immersed in the washing tanks and regeneration of the resins, and reinserted again, indefinitely, in ion exchange circuit without interruption of the desalination cycle and energy production and without costs for heating the water or replace the membranes. If we want to exploit the immense riches of the sea, floating solutions have no alternative. The systems must be designed supported from above, since it cannot exist electromechanical equipment that can work to the abyssal depths. The sustainability of global systems is not only based on high technologies and special materials but above all on the physical basic principles, chemical, hydraulic and mechanical. The first problem that could face this solution is to provide a home and a job to migrant peoples fleeing war and hunger.

FLOATING SYSTEM, HYDROELECTRIC, DESALTER, EXTRACTOR OF CALCIUM AND CARBON FROM MARINE DEEP WATER.  
<http://www.spawhe.eu>

No one has ever proposed changing the primary source of world energy from thermal to fluid dynamics, with submerged and compressed hydroelectricity that does not need hydraulic jumps or even dams. The existing ones will be used in the opposite way to the motivation from their conception because energy must be produced without dispersing water with hydraulic jumps. But above all it is necessary to decarbonize and denuclearize all global terrestrial, aeronautical and space transport because water, air and gravitational force are perfectly complementary to extract clean energy directly from the terrestrial environment. In some cases it is enough to use some existing inventions better. Among which, centrifugal pumps that, mounted backwards, can also be used as turbines, and that, appropriately modified, with a double separate supply up to the impeller, can allow the infinite recovery of

energy-producing water, the bypassing of the recycling pressure and the insertion of the same water into the pressurized production cycle, to repeat the same production cycles endlessly until the materials wear out.

The bypassing of pressure is the basis of the SPAWHE system, and can also allow the production of electromagnetic energy inside the bodies that can also be used in space, carrying with it all the necessary elements. For these reasons, the undersigned has conceived the future space race, as long caravans specialized in the production of the necessary spare parts that should assist each other. The current space exploration with fuels is only a useless waste of economic resources, increased pollution and space junk. We will be ready for the space race only when we learn to extract clean and inexhaustible energy from the terrestrial environment, which the current ruling class is boycotting in every way. Therefore, to go into space we must start from the production of artificial light, chlorophyll photosynthesis, the cultivation of food plants, the recycling of food waste, the global purification of organic and inorganic waste, in infinite cycles integrated with particles present in interstellar dust, captured by vacuum pumps, alongside global linear motors that, working with the same interactive terrestrial principles, would also produce the joint thrusts of Newton and Lorentz, always with the raw material extracted from the closed and pressurized environment at the terrestrial atmospheric pressure of the carriage traveling in space, occupied mainly by elderly human men equipped with artificial hearts that oxygenate the blood, energy-autonomous and artificial organs that will have replaced the natural organs. But the brain and DNA will be human.



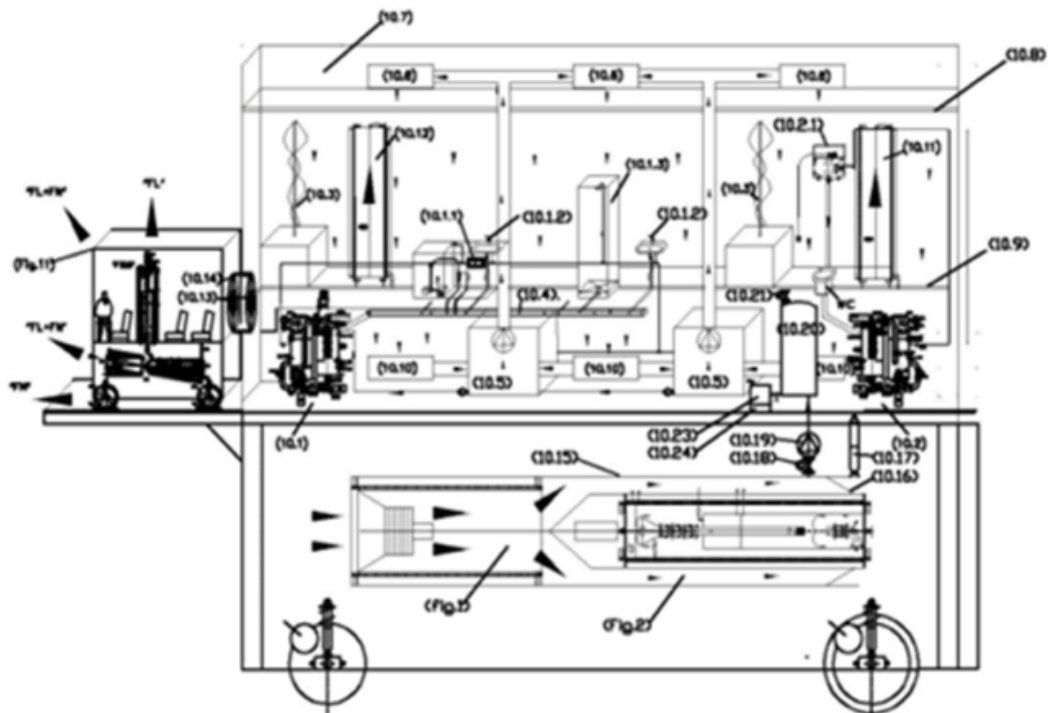

"FIG.10"

(10.1) domestic water purification plant; (10.1.1) ultraviolet disinfection system; (10.1.2) drinking water withdrawal point; (10.1.3) shower; (10.2) toilet waste water treatment plant; (10.2.1) toilet drain pan; (10.3) hydroponic cultivation; (10.4) waste water collection channel; (10.5) purification, humidification and air recycling system; (10.6) electrostatically polarized air inlet vents into the environment; (10.7) ceiling air distribution plenum; (10.8) regenerable filter ceiling in steel straw; (10.9) grilled floor with air passage; (10.10) electrostatically polarized air intake vents; (10.11) water reserve tank with external solenoid and vertical circulation of permanent magnets to produce Lorentz thrust; (10.12) compressed air reserve tank with external solenoid and vertical circulation of permanent magnets to produce Lorentz thrust; (10.13) Airtight passage porthole; (10.14) electromagnetic flexible metal bellows with external vacuum-tight gasket; (10.15) external connection steel tunnel between the electric turbofan fig 1 and the compressed hydroelectric primary energy production plant of fig.2; (10.16) truncated conical sector closure of the interstellar dust collection tunnel by means of a steel rope which runs in rings external to the closing cone; (10.17) electric actuator for activating dust collection closure; (10.18) shut-off solenoid valve; (10.19) electric vacuum pump; (10.20) high vacuum dust collection tank; (10.21) air inlet solenoid valve at atmospheric pressure; (10.22) solenoid valve for interstellar dust output; (10.23) electrostatic filter; (10.24) removable container for interstellar dust; (Fig. 11) interstellar local displacement vehicle.

I think it is no coincidence that none of my forty inventions have been realized, having put my finger in the wounds of governments and multinationals that support each other at the expense of the poorest and most defenseless, who have no weapons to defend themselves, no political associations and

trade unions that represent them, such as children, the poor, the unemployed and finally, inventors without a master, who are not even recognized as having intellectual property, which is also recognized to those who write a simple song. From private inventors, not linked to governments and multinationals, the UN, which is the most important world institution, also demands the payment of patent maintenance fees, instead of verifying the social utility of inventions and financing their experimentation with public money. Governments and the United Nations have delegated the development of the earth to multinationals, committing the very serious crime of omission of public acts in the exercise of public functions. I cannot afford the support of a major law firm, otherwise I would sue the United Nations for the crime of omission and for the failure to recognize the intellectual property on my unfunded inventions, for which I have paid national or international filing fees. No one can force an inventor to become an entrepreneur of new environmental and energy solutions, when the main customers, which are the United Nations themselves and the world governments are not interested in such solutions. Unfortunately, the problem is even more serious because even the global environmental oppositions prefer slogans to solutions they do not understand.

Fluid dynamics with the invention of electricity could have made great strides in the production of terrestrial energy, but instead it plays a marginal role. Although the first experiment with an electricity production network was carried out by means of fluid dynamics in 1870 with the coupling of a dynamo to a hydraulic turbine, the first public lighting network was powered by a thermoelectric plant that was installed on Pearl Street in New York in 1882 to supply public lighting. Since then, the primary source of electricity, up to the present day, has remained thermoelectric. From the following article available online <https://it.dsnsolar.com/info/energywhat-electricity-sources-po>

wer-the-world-101768614.html#, I extract the following data, updated to the year 2022. The energy sources are as follows: Coal still leads the rankings for electricity, representing 35.4% of global production, followed by natural gas at 22.7% and hydroelectric at 14.9%, nuclear 9.2%, wind 7.2%, solar 4.5%, other sources 2.7%.

From the list above, it is clear that humans have chosen above all thermodynamic energies, with fossil fuels that produce combustion oxides, CO<sub>2</sub>, steam; nuclear ones that produce radioactive waste, immense quantities of steam and high risks of radioactive contamination due to accidents (Chernobyl, Fukushima, etc.); solar panels, with bulky materials subject to aging, with discontinuous yields, easily damaged by large atmospheric disturbances, not usable in colder countries and that in hot countries, however, increase the quantity of steam compared to the natural evaporation of the earth's surface, which notoriously, is the true climate regulator of the planet based on the ion exchange with the area of the atmosphere called "ionosphere". Finally, let's talk about wind turbines, which ruin landscapes and produce energy in a discontinuous way, they also interfere with the natural ion exchange with the ionosphere and involve the transport of energy on high pylons which is another phenomenon underestimated by climate science that increases the production of unwanted lightning. I mention lastly hydroelectric energy, which is the only truly sustainable energy on the planet, today at 14.9%, but has the potential to reach 95%. Unfortunately, it must be completely redesigned because it does not need the hydraulic jump to be produced. Therefore, in the version coupled with compressed air it can produce mobile electrical energy that can be used in agricultural tractors and transport of all types. Including aeronautical, space, marine and submarine ones. Because water and air, due to their physical characteristics, if kept at the temperature of the terrestrial environment, can work at any operating pressure and do not wear out, recycling themselves almost infinitely, without accumulators of electrical energy,

compressed air itself being the most powerful accumulator of terrestrial energy.

SPAWHE energy and purification solutions were discovered because I was trying to seriously clean fossil energy. While the official world science, to repair the damage caused by fossil energy, instead of trying to clean fossil energy, has studied new energies, such as the new nuclear, and alternative fuels, jumping from the frying pan into the fire, because nuclear energy is even more incompatible with the Earth's environment and alternative fuels cost much more than fossil fuels and cannot avoid producing steam which is a greenhouse gas even more harmful than CO<sub>2</sub> and cannot be eliminated from the atmosphere. Instead, the CO<sub>2</sub>, the SPAWHE system, not only captured it, it also used it in favor of the environment. Unfortunately, always virtually, without funding. In fact, it would have produced carbonates with artificial rains in limestone greenhouses, after having modified the world's chimneys with a specific international patent, with the double function of electrostatic filtration of combustion oxides and capture of CO<sub>2</sub>, which having a non-polar molecule cannot be captured with electrostatic filters, but only with inorganic chemistry. This solution of mine, did not please the current world ruling class who attempted to hide the CO<sub>2</sub> underground with the C.C.S. system after having cleaned the fuels with an expensive chemical wash, which lowers the thermal efficiency by about 12% for liquid fuels and gas and by 30% for coal. This crazy scientific and economic attempt failed miserably since storage sites were needed at depths of about a thousand meters underground, not without having spent a few hundred billion dollars in research of all kinds. However, they would not have solved the problem, because an accidental release of the gas in high concentration, due to seismic shocks, where it would occur would produce catastrophic effects. Just type the words "Nios effect August 21, 1986" into Google and read what happened on that fateful day: the death by poisoning of men and animals present in the area.

Fluid dynamics is a simple and linear science and technology, well known to science, which if applied cold would have communicated much better than thermodynamics with electromagnetism, electronics, modern computer science, which, like the induced circuits of motors and alternation cannot function at temperatures higher than those of the terrestrial environment, especially if we want to add together the forces of Newton and Lorentz. Unfortunately, the world ruling class, in order to speculate on the easy profits allowed by fossil raw materials, has set aside the correct use of the principles of action and reaction which are not only fluid dynamic, but also preferably developed cold.

It is enough to remember the theorem of Daniel Bernoulli (1700 – 1782) which establishes an inverse relationship between the speed and the pressure of a fluid: if the flow of the fluid is fast, the pressure is lower and vice versa. Even the hydrodynamic paradox of Giovanni Battista Venturi (1746 – 1822) says the same thing: at the points where the duct narrows the speed increases while the pressure decreases. These phenomena allowed me to invent the pump with the double separate power supply up to the impeller, which would allow us to insert into the pressurized recycling circuit of an autoclave the same amount of water that we let out of the circuit to produce electricity in a smaller turbine with immense energy and purification advantages. Because the autoclave recycling pump, working in a closed circuit, would absorb very little energy, but at the same time, it would supply the pressure to the open circuit of the turbine that would power the electric current generator. Since through the centrifugal pump with the double separate power supply up to the impeller we would return to the autoclave the same amount of water that came out, we would practically steal the pressure energy from the compressed air of the autoclave cushion, but we would absorb only a small part of the electrical energy, which we ourselves would have produced through the alternator connected to the turbine. This would be

due to the fact that the volume of water in the autoclave does not change, since we exploit the static pressure of the compressed air. With this system, not only could we steal electricity from the earth's environment without paying energy bills; we could also steal, legally, the water purification costs, because if instead of inserting the same water that came out to produce energy through the second supply of the pump, we insert polluted water to purify, we users, also obtain purification for free, without committing any tax crime.

If it is true what Wikipedia reports that the centrifugal pump was invented in 1952, when the invention of electricity was still far away, the inventor (Erone Alessandrino) should be awarded a Nobel Prize in memory. Because, today they are very modern and could be used in both directions of flow, that is, as pumps to lift water and as turbines to produce electricity, which other new pumps cannot do.

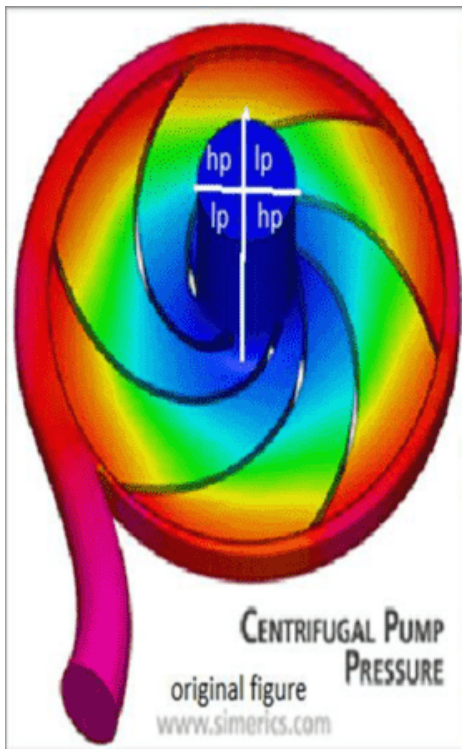

hp = high pressure = alta pressione  
 lp = low pressure = bassa pressione

<http://www.spawhe.eu/relativty-and-technology-in-the-new-hydroelectric-energy/>

In the pumps, the centrifugal force, having radial direction, creates a depression capable of attracting the liquid intubated, external to the pump. The low pressure area is at the center of the impeller, is called "eye of the pump" is colored in blue on the attached drawing and corresponds to the input of water into the impeller. In the green zone begins the pressurization of the liquid, which is completed in the red zone. It 'clear that if we feed a pump with two flow rates equal but different geodetic heights, we have a considerable energy saving because it is the water from the upper reservoir, which can be recycled, to raise the water from the lower basin, by means of mixing water and the expansion of the greater pressure that happens in green and red area. Obviously, with this solution, they do not serve multistage pumps and motors of great power, but single-stage pumps with double flow and small power engines , dimensioned for water recycling, and not for lifting. If we divide the two flow rates in four areas, arranged diagonally, also we balance the forces on the bearings. Each sector is always powered with the same water, but the rotation of the impeller allows the flow sequence on the same blade so that the one with greater hydrostatic pressure to push the one with lower pressure. In essence, it is what happens in multistage pumps but with lower costs in the construction of pumps, motors and absorbed powers. But the dual supply pumps, coupled to the turbines also allow the production of energy with the recycling and the water lifting. However, it seems that the pumps with dual power does not affect the authority of the environment, the pump manufacturers and investors in general. They find not investors.

Nelle pompe, la forza centrifuga, avente direzione radiale, crea una depressione capace di richiamare il liquido intubato, esterno alla pompa. La zona di depressione è al centro della girante, è chiamata "occhio della pompa" è colorata in blu sul disegno allegato e corrisponde all'ingresso dell'acqua nella girante. Nella zona verde inizia la pressurizzazione del liquido, che si completa nella zona rossa. E' evidente che se alimentiamo una pompa con due portate uguali ma battenti diversi, abbiamo un notevole risparmio energetico perché è l'acqua del bacino superiore, che può essere a riciclo, a sollevare l'acqua del bacino inferiore, per mezzo della miscelazione dell'acqua e l'espansione della pressione maggiore che avviene nella zona verde e rossa. Ovviamente, con questa soluzione, non servono pompe multistadio e motori di grande potenza, ma pompe monostadio con portate doppie e motori di piccola potenza, dimensionati per il riciclo dell'acqua, non per il sollevamento. Se dividiamo le due portate in quattro settori, disposti in diagonale, equilibriamo anche le spinte sui cuscinetti. Ogni settore è alimentato sempre con la stessa acqua, ma la rotazione della girante consente la successione dei flussi sulla stessa pala in modo che quello con maggiore pressione idrostatica spinga quello con minore pressione. Nella sostanza, è quello che avviene nelle pompe multistadio ma con minori costi nella costruzione delle pompe, dei motori e delle potenze assorbite. Ma le pompe con doppia alimentazione, abbinata alle turbine consentono anche la produzione di energia con il riciclo e il sollevamento delle acque. Tuttavia, sembra che le pompe con la doppia alimentazione non interessino le autorità dell'ambiente, i costruttori di pompe e gli investitori in generale. Esse non trovano investitori.

I used the conditional in describing my energy and purification solutions because I have never received public or private funding to implement them. They are all in a virtual state. But I am sure that they work because this has been my work for many years. The fact that no one has thought of these

solutions leaves me perplexed, but I cannot remain silent about the obvious errors made in the design of the world's anthropogenic plants. God specifically created incompressible air and compressible air, so that we could use them in this way to extract energy from the environment. Furthermore, I think that God wanted to demonstrate that if he did not create the air and water of the Earth in one day, but over several billion years, through nuclear explosions, primordial eras, magnetic pole inversions and many other natural phenomena, up to photosynthesis, the carbon cycle and the daily ion exchange between the ionosphere and the Earth's surface, he wanted to teach us that energy is not just a force, but a complex interactive, multidisciplinary phenomenon, without which no form of biological life could exist on the Earth's surface. The very fact that water easily polarizes into  $H^+$  and  $OH^-$  ions is part of God's supernatural design, which is infinitely superior to that of men. As a technical designer and installer of systems, I have tried to design chimneys, sewers, and purifiers differently, following the scientific organization of work, but I have gradually understood all the chemical, biological, and electrostatic phenomena involved, also thanks to publications by other researchers specialized in individual sectors, who have not been able to produce inventions useful for fighting global warming for the simple fact that transversal skills are needed. I myself would never have found them if I had not left my job as an employee as soon as I reached the minimum requirements for retirement. Employers pay technicians like me to carry out their daily work in the shortest possible time without using their imagination. For this reason, I believe I have had a sort of vocation, as others receive it, to be missionaries, doctors without borders, and other activities without thinking about personal enrichment. I would never have thought of finding myself in front of this enormous Pandora's box, where every day I myself learned new things. Luckily, today we have the internet and I have found many answers on the net. Not all answers produce inventions, but they clarify the general framework to produce



global and interactive inventions, which are the only ones that can stop global warming. Unfortunately, these inventions do not exist on planet Earth. I do not think anyone can prove me wrong because I have spent half my life installing industrial plants and half my life installing public environmental and energy plants. My goal was only to demonstrate that fossil energy can be cleaned, even with high energy costs, if they were necessary. The first phase was to study the purification cycles of water and air together, which strangely, on planet Earth are still separate. But studying the details, to economize the purification processes of water and air together, by pure chance, I realized that everything had already been arranged by the creator of the universe. It was enough to hypothesize to make the centrifugal pumps work in the direction of the gravitational force and put them in series with another similar pump, mounted in reverse to understand that I had solved both the energy problem and the purification of the Earth's energy, even if I still had many details to develop. It was 2014. Today I think that the planet Earth cannot be saved because of the hypocrisy of the world's ruling class and the scientific inconsistency of the opposition. In these years I have developed all the details that were necessary to develop without ever finding public and private interlocutors who assumed financial responsibility. I tried in every possible way to find financiers to create demonstration prototypes without succeeding. If I had succeeded, at most, I would have fought to obtain the intellectual property of my inventions, not the industrial one. I do not think that there can exist on planet Earth a billionaire who can cover such a vast field of wrong energy and purification inventions of planet Earth.

### **1. The difference between the science of the present and the past**

I blindly trust the science of the past that stopped to state

the correct fluid dynamic principles, which should have been supported by electrical and electronic scientists, who instead, strangely, did not do so, despite knowing that it is essential, for the correct development of the Earth and to go into space with sustainable solutions, to be able to add together the thrust of Newton and Lorentz. They know well that the electromagnetic thrust on planet Earth can only be produced cold with copper wires protected with insulating paints that cannot be fought with thermal energy. Why is electromagnetic and electronic science silent? Evidently, even the electromagnetic and electronic sector is dominated by the same economic powers that have produced global warming with fossil fuels, nuclear energy, current hydroelectric power, solar panels, wind energy and electric cars with energy accumulators. I do not trust the current world ruling class, not for political reasons but for scientific ones, because I have paid the fees for filing national patents and some international ones, including the pump with the double separate supply up to the impeller and I have not found any financiers. Politicians do not take on scientific responsibilities without consulting science. And science, through the patent trade, is in the hands of multinationals. In fact, all governments have stopped being entrepreneurs, including communist countries. What governments manage directly is always in economic failure situations, due to political clientelism, right and left. While science and justice should be above partisan interests.

It is no coincidence that the SPAWHE systems, which would be fundamental to renewing the steel industry by cleaning up fossil energy through limestone greenhouses and artificial rains, have not been financed by multinationals or governments. The same thing happened to artificial welling, which could multiply quality food production, based on fish, and is at year zero. Yet this solution is a valid alternative to the sustainable use of petroleum derivatives because, to work, artificial welling must be far from continents and the

dangers of tsunamis.

The invention of the artificial heart, an oxygenator of human blood, which could make man almost immortal, integrated with robotics and cybernetics, has not been financed either.

If we want to save the planet, world leaders must take responsibility for quickly replacing fluid dynamics with thermodynamics, because energy extracted coldly from the Earth's environment is powerful, rational and costs nothing.

There is no sector that would not benefit from such a replacement, including blast furnaces and incinerators, which could continue to operate with fossil fuels because only with the fluid dynamics of the Spawhe system can the damage caused by combustion fumes be eliminated. But the sectors that would benefit the most, after having solved the climate problem, are precisely global transport: land, sea, air, submarine and space, because the energy produced coldly with air, water is breathable by humans, and infinitely recyclable and allows the Newtonian and Lorentz thrust to be added together. There has been much talk about the Lorentz thrust due to its importance, but no one has ever achieved it on means of transport, due to the fact that it must be coupled directly to the primary source of energy, which must be cold. I think that if Einstein, Maxwell, Lorentz, Tesla, Ferraris were still alive, they would have realized the usefulness of hydroelectricity without the hydraulic jump that previously would have prevented droughts and floods, allowing a rational distribution of world waters, with the advantage of the complete elimination of high voltage electricity distribution networks, not only for costs. Above all because such networks interfere with the natural ionic exchange between the Earth's surface and the ionosphere, contributing, together with steam and CO<sub>2</sub> (which would also be eliminated with the SPAWHE system) to the current global warming and the unfair distribution of world wealth.

Newspapers, television, universities, unions, political

parties, churches do not talk about the SPAWHE system because everyone thinks that the more noise they make, the more right they are. Advertising is the soul of commerce. I think that only in silence and solitude can we concentrate on the details and find solutions.

Newton asserted that from a scientific point of view, what science knew was a drop, what it did not know was an ocean. Only in 1866 did the German inventor Werner von Siemens (1816-1892) develop the first self-starting electric motor. To see the first exploitation of the principle of inertia for energy purposes, man had to wait for the construction of the first real hydroelectric power plant, which began operating in 1882 in Wisconsin (United States), near Niagara Falls. Unfortunately, electrical energy, produced by exploiting the principle of inertia, has remained conceptually stuck in 1882, as, even today, in all the world's hydroelectric power plants, once the water in the basin is exhausted, the energy production is also exhausted. This fact has produced more damage than benefits to the earth's environment as very few hydroelectric power plants operate all year round. Only those located on watercourses with natural hydraulic jumps satisfy these requirements. Most are power plants powered by artificial basins that accumulate rainwater or that due to the melting of snow that operate for a few days a year with maximum flow rates. Then they have to wait for the basins to fill up again in order to produce new energy. These power plants have produced more disasters than benefits because in order to produce energy, the managers are forced to risk the production of floods, due to the fact that rainwater, finding the basins full, is forced to pour into the valleys below with greater violence, creating immense damage and wasting the water, which goes towards the sea unused in the winter months, instead of being accumulated in the valleys to produce hydroelectric energy without the hydraulic jump, as the undersigned has been proposing in vain since 2015, having found the solution of submerged and compressed

hydroelectricity that would not disperse water during energy production. Furthermore, the same solution would allow energy to be produced all year round even in mountain basins without risking floods, as it would not be necessary to fill the water basins to the maximum levels. For unknown reasons, governments and multinationals, by mutual agreement, have not taken into consideration any of the environmental and energy inventions described on the website <https://www.spawhe.eu>, as if the undersigned were writing in a language unknown on planet Earth.

I repeat the concept of energy without the hydraulic jump, as it divides the production of energy into two phases:

The first overcomes the state of inertia with an electric motor and a pump that sends the water in the direction of the gravitational force.

The second phase is the real production of hydroelectric energy that exploits the kinetic energy produced by the pump above by means of a turbine coupled to a current generator.

Furthermore, if the hydraulic jump is very low and we need to produce a greater quantity of electrical energy, we can reinforce the flow rate and pressure of the recycled water with a parallel system that produces compressed hydroelectric energy. Which is another invention of the undersigned that can find infinite applications in fixed and mobile systems. I have been writing these solutions for ten years now, without finding public and private interlocutors. Before describing these solutions, I had to describe how to close the cycles of fossil energy cleaning, first capturing CO<sub>2</sub> from the atmosphere and neutralizing it in the interactive purification process between water and air described separately, otherwise I would never have had the idea of putting pumps and turbines in series in the same water descent pipe and not even the idea of modifying the centrifugal pumps which are the only pumps that can allow the correct mixing of the

pressurized recycled water with the water discharged by the hydraulic turbines, after having allowed the production of hydroelectric energy without the hydraulic jump. It is obvious that after this invention the system of producing compressed hydroelectric energy without the hydraulic jump has become an integral part of the cleaning of urban fossil energy. It is not obvious that the entire world ruling class has not understood how the entire system works and has not asked for explanations. I think that the world ruling class has understood very well how my system works because I have described it in Italian and English in many articles published on the web and the billionaire Elon Musk should have understood it too, who promised 100 million Euros to whoever captured and cleaned fossil energy. I have never received this prize and I do not know who he gave it to.

As I wrote in the following article of the **01.02.2021** <https://www.spawhe.eu/open-letter-to-mr-elon-musk-who-promised-100-million-dollars-to-those-who-manage-to-capture-co2-from-the-atmosphere/>, My reference is the world public institutions, above all, the UNITED NATIONS that should feel the duty to update the state of the art of science and technology worldwide, also taking charge of the experimentation of inventors not tied to the world economic power and recognizing the intellectual property of inventors, like myself, who do not have the economic means to experiment on their own with inventions of public social utility. The UNITED NATIONS that manage the WIPO (World Intellectual Property Organization) and organize the COP (conference of the parties), do not feel the duty to experiment with inventions of public utility proposed by free inventors, not tied to the world economic powers. They do not even feel the duty to finance experimentation with public contributions at least of artisanal experiments demonstrating the functionality. The current trade of public patents towards multinationals has completely cut off from funding inventors free from the centers of public and private power. Government patent

offices, in addition to demanding patent filing fees, also demand annual maintenance fees, as if inventions were a perishable product and do not collaborate in experimentation with their experimental centers (at least in Italy, which should be one of the most democratic countries, being part of the G7). Of my forty inventions, not even one has been tested, even though from 2006 to 2024, we have had right-wing and left-wing governments and many important factories, such as ILVA in Taranto, could have benefited from my combustion fume purification system. ILVA risks closing down permanently due to the serious environmental problems it produces, but neither governments nor oppositions have noticed that my solution to cleaning up fossil fuels has become much more sustainable since 2015 by reducing energy costs with the invention of submerged and compressed hydroelectric systems, which have only one flaw: They were not invented by public power centers, such as Enea and ENI, which have refused my collaboration since 2009. The following article in Italian from 2013, when I had not yet created the Spawhe website, shows the indifference of public bodies towards my work as an inventor. <https://www.meteoweb.eu/2013/01/inquinamento-globale-botta-e-risposta-con-eni/179710/>. ENI wrote to me that it was not interested in my fossil energy purification system because it already complied with existing regulations. While Enea did not have sufficient funding to develop its own projects, it could not also deal with mine, as if I were a competitor. Not an Italian citizen who wanted to collaborate invited with a special letter by the president of Enea himself, shortly before leaving his institutional position.



Il Presidente

Roma, 2 luglio 2009

Prot. ENEA/2009/ 37058 /PRES

Gentile Sig. Pezone,

La ringrazio degli articoli che cortesemente ha inviato alla mia attenzione.

Al fine di approfondire gli aspetti tecnici e le implicazioni economiche dei sistemi e delle tecnologie da Lei prospettate, La prego gentilmente di voler contattare il Dr. Roberto Morabito, Responsabile della Sezione Metodi di Analisi e Prevenzione del Rischio Antropico, che potrà organizzare un incontro con gli esperti ENEA del settore.

Può contattare il Dr. Morabito tramite posta elettronica all'indirizzo [roberto.morabito@enea.it](mailto:roberto.morabito@enea.it).

Cordialmente,

Luigi Paganetto

My interactive solutions, I had to continue to develop them alone without public and private money, while they concentrated on hiding the CO2 underground. Italy was saved from such a disastrous import by the nuclear disaster that occurred in Japan in Fukushima, where on March 11, 2011, about 50 minutes after the earthquake, the tsunami from the Pacific Ocean reached the Fukushima nuclear power plant. The tsunami waves more than 10 meters high hit the coast, the nuclear reactors of the plant were submerged. The victims were over



16,000. But the environmental consequences are certainly even more serious. However, the world ruling class still insists on trying to produce energy with the new nuclear and with new fuels. While the undersigned without a single euro of public and private funding, trying to clean fossil energy, has discovered that it is not worth cleaning it, but extracting it cold already clean from the earth's environment.

# THE INTERACTIVE FOSSIL GLOBAL ENERGY DEAD IN THE BAND KILLED BY THE SILENCE OF THE ENVIRONMENTAL AUTHORITIES

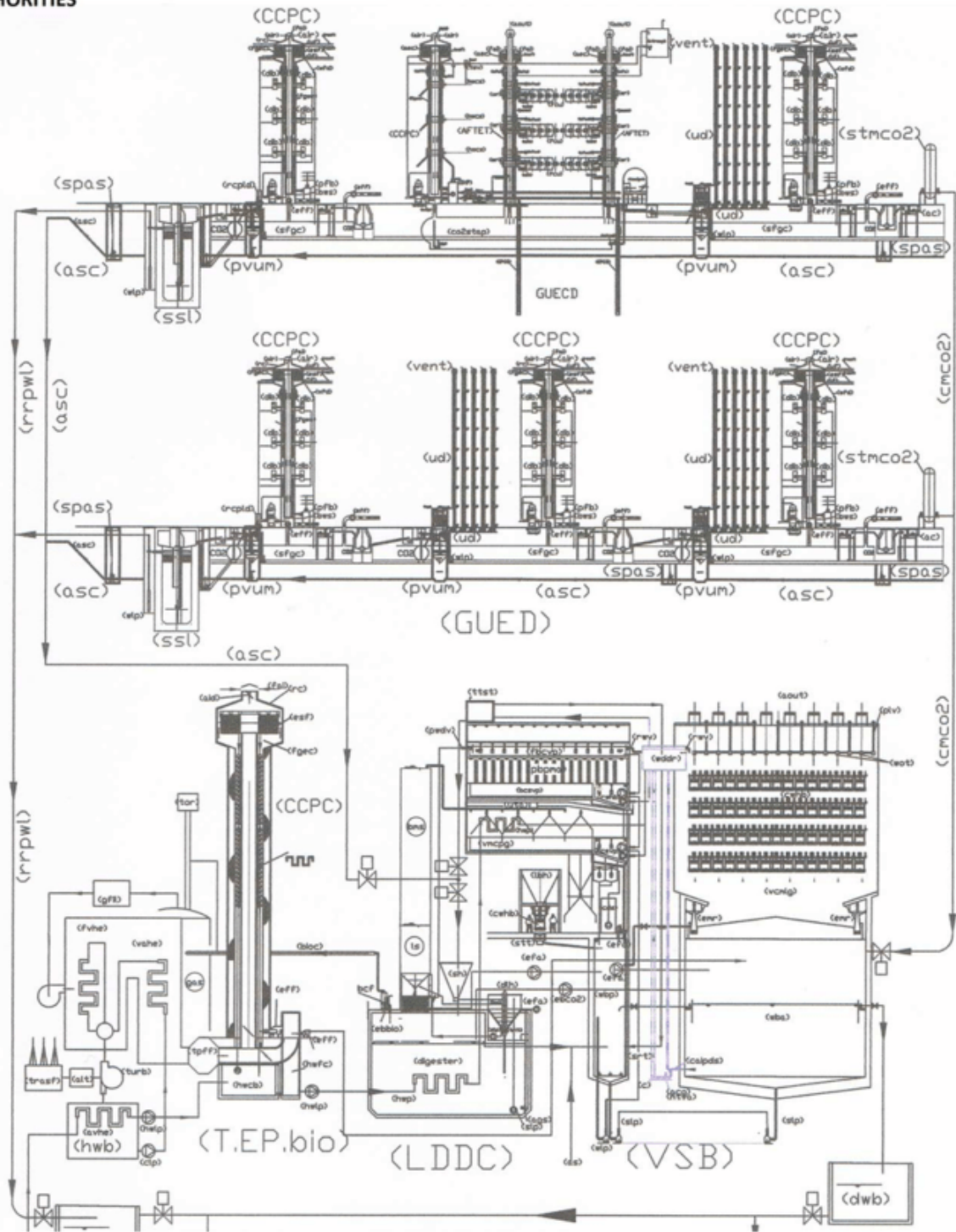

**WWW.SPAPHE.EU**

This figure represents the fossil interactive energy that could be created by modifying the chimneys and the urban plants, described in the old initial page of <http://www.spawhe>. To economize this system is born the interactive compressed hydroelectric energy, which does not emits pollution and CO<sub>2</sub> and can be mounted even on means of transport, which is described in the new home page of <http://www.spawhe>. These two models of universal development, sustainable and protective of the environment were developed by a Neapolitan inventor, but ignored both by the world environmental authorities. On the other hand, UNESCO has recognized Neapolitan pizza as a World Heritage. The Neapolitans can not have both awards.

## MANY WORDS ON THE POLLUTION OF BLAST FURNACES AND INCINERATORS BUT NO PROPOSED SERIOUS ON THE COMPLETE DEPURATION

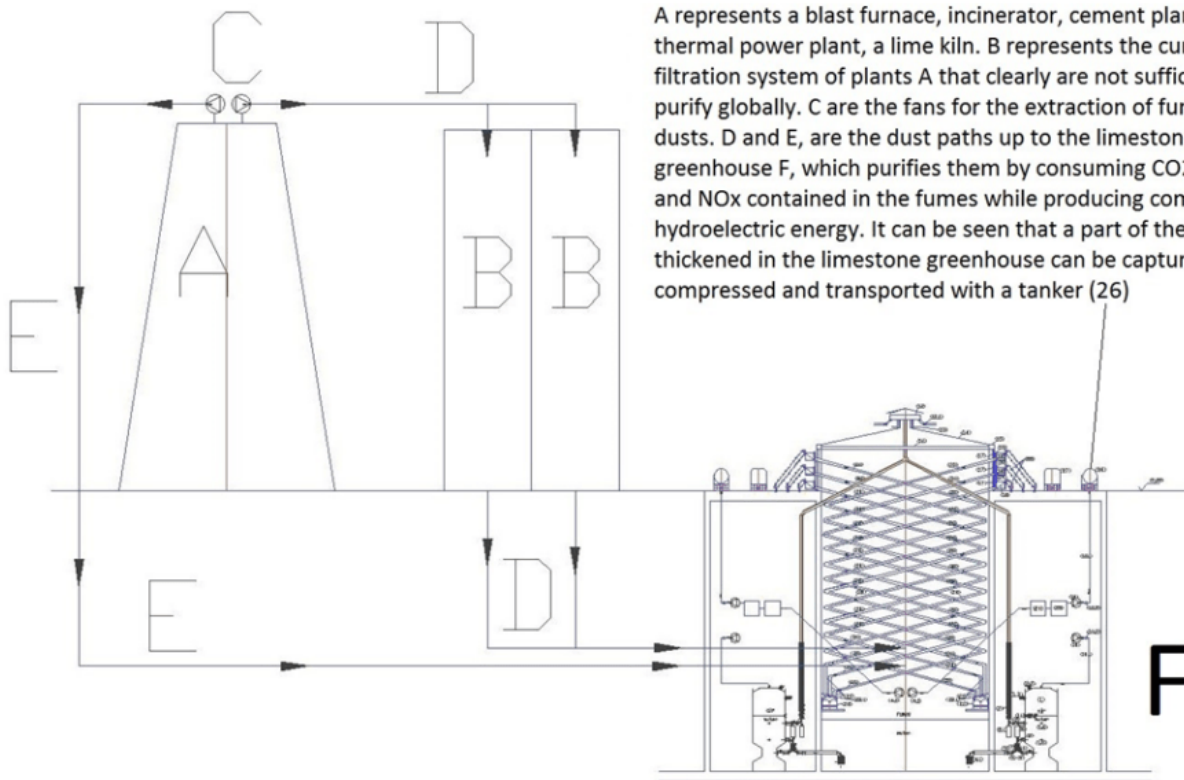

A represents a blast furnace, incinerator, cement plant, a large thermal power plant, a lime kiln. B represents the current filtration system of plants A that clearly are not sufficient to purify globally. C are the fans for the extraction of fumes and dusts. D and E, are the dust paths up to the limestone greenhouse F, which purifies them by consuming CO<sub>2</sub> the SO<sub>x</sub> and NO<sub>x</sub> contained in the fumes while producing compressed hydroelectric energy. It can be seen that a part of the fumes thickened in the limestone greenhouse can be captured, compressed and transported with a tanker (26)

The steel cycle, which can be produced or recycled only by melting, that of non-recyclable solid waste, which must necessarily be incinerated, the production of lime and cement are incomplete, like those of thermal power stations, but produce toxic emissions, powders and CO<sub>2</sub> in much greater quantities. Therefore, these systems, like thermal power plants, must be designed differently from the current ones. Even though today, more than sixty percent of the world steel is produced with electric ovens, and many waste is burned with the same system, which reduces toxic emissions, we can not say that electric ovens also reduce CO<sub>2</sub> emissions, being the primary source of electricity always due to fossil thermal power plants. In addition, even electric ovens for accelerated processes use fossil or biological fuels. Therefore, not only must the primary source of energy be changed, which must become hydro-electric compressed with water recycling. The current chimneys, both of the thermal power stations and of the melting furnaces and of the incinerators, must be eliminated, because no filtration in the world can neutralize the fossil or biological CO<sub>2</sub> that it is. In fact, if we want to lower the percentage of CO<sub>2</sub> in the environment we must also neutralize the biological one. In addition, even electric ovens, although in smaller quantities, produce toxic substances such as NO<sub>x</sub>, SO<sub>x</sub>, fine powders. The undersigned has already obtained international recognition of patents that eliminate the chimneys and replace them with small and large scale greenhouses, but these have not found lenders, especially public, therefore, also proposes those underground hydroelectric, which are simpler and cheaper from the point of view of the movement of calcareous material. These greenhouses will not only neutralize CO<sub>2</sub> in a sustainable way for the environment, they can also replace the existing large and small water purifiers of existing waters, which produce acidic waters, producing lower alkaline water costs, which counteract the acidification of oceans.

To carry out the same purifying and alkalinizing function, without any environmental impact, rivers, lakes and artificial basins can also be added, producing the same water that circulates all the electrical energy needed to power the ovens, incinerators and the neighboring cities.

The same Stellantis ex Fiat and Alfa Romeo (where I worked as an employee from 1970 to 1986) could benefit from my invention of the hydroelectric car with driving torque applied to the periphery of the wheels, innovative both from an energy and mechanical point of view, filed in 2016, for which I was also granted the patent, but I have not found financiers.

# CAR WITH HYDRO POWER ENGINE

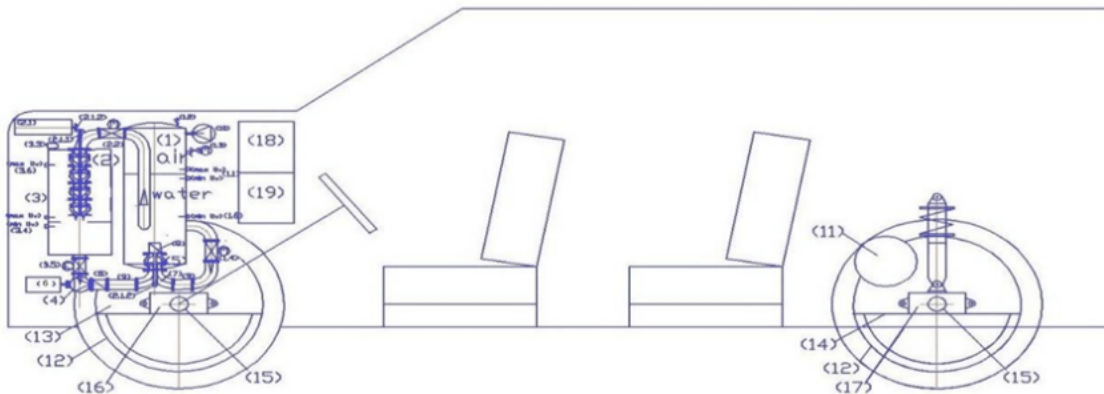

<http://www.spawhe.eu/hydroelectric-power-auto-with-torque-peripheral-to-the-wheels-novit%C3%A0/>

Legend: (1) autoclave pressurized tank; (1.1) level regulator with capacitive probes; (1.2) safety valve; (1.3) manometer with shut-off valve; (1.4) motorized valve flow control with position transmitter; (1.5) pressure or flow transmitter; (1.6) minimum level probe in the start system; (2) pump used as a turbine (pat); (2.1) alternating current generator; (2.1.1) bushing with sealing ring; (2.1.2) angle diverter with conical gears; (2.1.3) transmission shaft; (2.1.4) transmission shaft protection tube (2.1.5) double curve with septa crossed separators in low pressure (LP) and high pressure (hp); (2.1.6) septa separators of flow; (2.1.7) closed type; (2.1.8) Diffuser of the pump; (2.2) motorized valve to supply turbine with flow adjustment; (3) water transit tank at atmospheric pressure and containment pat; (3.1) motorized valve to feed pressurized water network; (3.2) motorized valve bypass supply at low pressure; (3.3) air valves; (3.4) Water level control with capacitance probes; (3.5) motorized valve for water supply at low pressure; (3.6) maximum level probe in the start system; (4) electric pump to supply in low pressure (5) electric pump with double separate supply until the impeller; (6) pump drive motor, with variable speed, controlled by an inverter; (7) double curve with septa crossed separators in low pressure (LP) and high pressure (hp); (7.1) septa to flow separators; (8) check valve. (9) flow diverter stub pipe; (10) electrocompressor; (11) self braking engine with variable revs (11.1) sprocket gears; (12) wheel rim; 12.1 ring gear; (13) motorization support of front wheel; (14) motorization support of rear wheel; (15) stationary shaft; (15.1) bearing; (15.2) wheel rim mounting flange; 15.3 brake disc; (16) front Axle; (17) rear axle; (18) electric command and control panel; (19) heat pump for summer and winter air conditioning.

**14.01.2017 <http://www.spawhe.eu/hydroelectric-power-auto-with-peripheral-torque-to-the-wheels/>**

Electric cars are completely wrong. It doesn't matter whether they are Chinese, European or American, as long as they have to be recharged with energy produced by current nuclear thermal energy, they will not solve any environmental problem but will make it worse by requiring a greater amount of energy to be produced at high costs for cars and electricity distribution networks. There can be no sustainable future if we do not get to use a clean, economical, inexhaustible energy

source such as the compressed hydroelectric one conceived by the undersigned.

**14.01.2017 <http://www.spawhe.eu/hydroelectric-power-auto-with-peripheral-torque-to-the-wheels/>**

Electric cars are completely wrong. It doesn't matter whether they are Chinese, European or American, as long as they have to be recharged with energy produced by current nuclear thermal energy, they will not solve any environmental problem but will make it worse by requiring a greater amount of energy to be produced at high costs for cars and electricity distribution networks. There can be no sustainable future if we do not get to use a clean, economical, inexhaustible energy source such as the compressed hydroelectric one conceived by the undersigned.

I would like to mention on this occasion what I have already written in a previous article which is the following: **14.06.2020**

**<http://www.spawhe.eu/a-small-italian-miracle-of-giuseppe-contes-government/>** "After refusing to comply with the bureaucratic requests of the Italian patent office for the umpteenth time, instead of being punished by not being granted the patent, as has always happened, unexpectedly, I was granted the patent. Obviously, this patent is useless because I have no intention of turning into an entrepreneur at seventy-one, but knowing the narrow scientific mentality of the Italian patent office, I think it was forced to swallow the toad by the new government of Professor Giuseppe Conte. This is the patent certificate granted to the undersigned under the Conte Government.



*Ministero dello Sviluppo Economico*

Direzione generale per la tutela della proprietà industriale

Ufficio Italiano Brevetti e Marchi

## ATTESTATO DI BREVETTO PER INVENZIONE INDUSTRIALE

Il presente brevetto viene concesso per l'invenzione oggetto della domanda:

N. 102016000087373

TITOLARE/I: • pezone luigi antonio

DOMICILIO: Luigi Antonio Pezone  
Via Caserta parco verde 33  
81055 Santa Maria Capua Vetere

INVENTORE/I: • Pezone Luigi Antonio

TITOLO: AUTO IDROELETTRICA CON COPPIA MOTRICE PERIFERICA ALLE RUOTE.

CLASSIFICA: B60L

DATA DEPOSITO: 26/08/2016

Roma, 14/07/2020

Il Dirigente della Divisione  
*Loredana Guglielmetti*

But from a government point of view, the Conte government behaved like the previous government of President Berlusconi and the subsequent one of the Draghi government, as described

in the following article.

**12.02.**

**2021**, <https://www.spawhe.eu/open-letter-to-the-new-prime-minister-of-the-italian-government-mario-draghi-in-the-field-of-environment-energy-and-public-health/>,

Italian and world governments do not have the courage to propose alternative solutions to those of multinationals. The Conte government, for not having had this courage, not only fell. It also lost 2/3 of its electorate. Nobody wants or can implement sustainable inventions because political and economic power is still in the hands of those who produced global warming and the unequal distribution of world wealth. Eighteen months later, following regular elections, the Draghi government was succeeded by the Meloni government, which even re-proposed the Mattei plan, with an evident leap into the past.

**10.10.2022**

<https://www.spawhe.eu/open-letter-to-the-new-italian-prime-minister-giorgia-meloni-on-the-subject-of-environment-and-energy/>;

In the year 2024, an inventor free from political and economic power centers, finds no points of reference even in the world press

05.11.

2022

<https://www.spawhe.eu/cop-27-open-letter-to-deputies-senators-world-information-bodies-on-the-subject-of-the-environment-and-energy/>, Even science, to bring home a salary, does not realize that the scientific organization of work, if it were, applied correctly, could also remedy scientific and technological failures, because if in the design and installation of anthropic plants, legislators imposed to close all the cycles that open, almost automatically, all the inventions of SPAWHE would come out, which instead, everyone, by common agreement, pretends not to understand.: **25.01.2023**, <https://www.spawhe.eu/science-and-politics-do-not-know-terrest>

rial-physics-and-the-scientific-organization-of-work/,

As I write this article I read that Stellantis and Catl (a Chinese company) have announced that they have reached an agreement to invest up to 4.1 billion euros in a 50% joint venture to build a large-scale European lithium iron phosphate (LFP) battery plant in Zaragoza, Spain.<sup>1</sup> This confirms that the current world ruling class does not know what environmental sustainability means and is going in the opposite direction because electric cars not only increase the production of current thermal power plants, but also the costs of electricity distribution. While SPAWHE would eliminate not only thermal power plants but also electricity distribution by extracting energy from the water network without wasting even a drop of water, preventing both floods and droughts.

These solutions should be taken into consideration, above all, when rebuilding the cities destroyed by the war in Ukraine and the Gaza Strip, because with the bombings, the first thing that is missing is electricity that forces the population into darkness and cold. While with the compressed hydroelectric system everyone could be energy autonomous and even live under a tent without being left in the dark, cold and excessive heat at any latitude and longitude of the planet. The world silence on SPAWHE's inventions is incredible.

The entire world ruling class, public and private, that has enriched itself with gas and oil does not want to resign itself to using these resources differently because it has become accustomed to easy economic gain without knowing how to design alternative solutions for the use of these resources. I understand their problems and I also propose the solution which is to use oil derivatives to build artificial islands off the oceans, far from the dangers of tsunamis dedicated to fishing with artificial welling, as natural welling is not sufficient to feed the entire future population. Obviously, these islands could also be used for tourism purposes. The study of the scientific organization of work is essential to



use the right resources in the right place. I was thinking about the solution of artificial welling long before I found the solution of coldly extracting electrical energy from the terrestrial environment, which is certainly more suitable for the simultaneous realization of physical, biological, chemical and electromagnetic processes that would not be possible to put together with thermal plants, since the processes are, above all, cold fluid dynamics. Unfortunately, this ruling class wants to live off the proceeds and does not want to change anything. I think that technical and scientific culture, even more than literary culture, must teach the elementary concepts of survival.

On planet earth no one has ever taught that if we use pumps in the direction of the gravitational force coupled in the same circuit with pumps mounted backwards they perform the function of a turbine, coupled with current generators we can produce electricity.

If we modify the centrifugal pumps that instead of having a single power supply, have two side by side, which remain separate until they enter the same impeller, and we feed them with different pressures, so that the low pressure water is inserted into the pressurized recycling circuit of an autoclave that feeds a hydraulic turbine connected to a current generator, creating infinite cycles at the same time, energetic and purifying, since every time the water passes through the pressurized autoclave it absorbs a greater quantity of oxygen.

Therefore, it is possible to simultaneously create low-cost purification and energy systems, exploiting the principles of Henry and Dalton regarding the purification aspect and the principle of Pascal regarding the energy gain, since the pressure in the body of the rotating impeller expands in all directions.

It should be obvious that to propose these inventions I am not

a beginner. Before proposing myself as an inventor I had to do a long seventeen-year internship in the industrial plants of the automotive industry, which until proven otherwise, even if I got the heat engines and even the electric cars wrong, as a scientific organization of work is always the most efficient because to competitively produce a complex product like a car many technologies come together at the same time and a designer, like myself who studied these plants for seventeen years, was able to put together more technologies, such as industrial painting systems, electrostatic welding fume filtration, internal transport systems and other innovations that I have noticed are completely absent in the public plants worldwide that deal with the purification and lifting of public water. In my nineteen years that I spent installing public plants from 1987 to 2006, I was not able to propose innovations, being a simple installation technician who had to respect the tender specifications. But I couldn't resist the temptation to become an inventor, as soon as I reached the minimum retirement requirements. You can't propose changes to human-made plants if you don't know how the sector in question works and scientifically organizes its work. Unfortunately, it seems that the vast majority of human-made plants in the world lack scientific organization of work, which is not applied unless there is a specific goal, such as beating the competition of similar companies that produce the same product. Companies copy each other but rarely risk radical innovations for fear of losing market share.

My inventions that aim to extract clean energy directly from the environment in every corner of the earth, however simple and logical, risk creating chaos on the world stock exchanges. But I say, isn't the chaos on the world stock exchanges better than continuing to produce wrong inventions and weapons of all kinds to destroy each other when the Creator of the universe has made our lives easy by allowing us to extract all the energy and food we need even tripling or quadrupling the world population, with the SPAWHE system, which is nothing but the

synergy between the anthropogenic plants connected to each other, which does not exist; the Antifacial Welling that would extract most of the food from the sea without polluting, which does not even exist; Submerged and compressed hydroelectric energy without the hydraulic jump, self-purifying and self-energetic, which costs nothing, being extracted from the atmospheric air, water and gravitational force. This is the only energy that has never been produced on planet earth. All the others are paid for, and in one way or another are also incompatible, producing CO<sub>2</sub>, steam, or simple long-distance transport on pylons that interfere with the natural ion exchange of the earth's surface with the ionosphere.

This energy does not need an electricity distribution network. Therefore, in the future, where it will be built, in the event of wars, such as in Ukraine and the Gaza Strip, the invaders will not be able to destroy it, leaving the civilian population cold and without electricity. In fact, with my system there will be no electricity networks, only water networks. Because electricity will be extracted from water and air without any other ingredients. Even if the invaders stop the water, they will not be able to stop the electricity because the water will be recycled. This means that at least in the reconstruction works and in the Gaza Strip, my inventions will have to be tested, but also in all the flooded areas in Europe and throughout the world. It is not enough to rebuild the embankments and make insurance policies against the inefficient plans of governments and multinationals. It is the entire model of terrestrial energy and purification development that is wrong from the foundations. If the gravitational force on planet earth is everywhere, even electrical energy without the hydraulic jump can be everywhere with water and air recycled infinitely because it is not consumed and the water is oxygenated more and more, every time it passes through the autoclave. This also applies to land transport and means of transport and work. Not only cars, but also buses, trucks, agricultural tractors, trains, ships,

submarines, airplanes and even spaceships. In fact, in the case of aerospace transport we can simultaneously use the Newtonian and Lorentzian principles to exit the atmosphere and in the next phase continue only with the Lorentzian force. For me, we do not need escape velocity to exit the atmosphere if we add together the Newtonian and Lorentzian thrusts.

Returning to the concept expressed by Newton, who believed in the sixteenth century that what we did not know was an ocean, I think that today we are in worse conditions, having produced an ocean of wrong inventions and that we should start again from the principle of inertia to rebuild modern society. Fortunately, we have developed excellent electrical, electromagnetic and electronic inventions that would dialogue perfectly with fluid dynamics, revised and corrected according to the SPAWHE system.

Every body to move in space must extract from the inertial reference system the energy to break the state of inertia, of uniform or accelerated motion, without interfering negatively with the surrounding environment from a chemical and biological point of view. In fact, the planet Earth is self-sufficient from a chemical and biological point of view and can feed the humans and animals of the planet only through a rational scientific organization of work that marginally concerns chemistry and biology, if not through the increase in the speed of processes, due to the increase in pressures and speeds of fluid dynamic circulations at the temperature of the Earth's environment, which are physical processes, which indirectly induce greater speeds also chemical and biological processes intended to increase food production, but also to speed up global transport and industrial production. Only in rare cases do humans need greater quantities of heat to melt minerals to produce steel, metal alloys, incinerate waste, These special plants and must be designed differently than the common plants in daily use by the world's population.

The principle of inertia, referring to the space cars used by

men who will go into space, must start from the photosynthesis created with artificial light that must also integrate the food production of travelers with an energy that can be breathed by man and that is not consumed and is recycled and purified and reintegrated infinitely, as described in the specific articles on this topic.

Today, in 2025, we can say that we have understood many things about the ocean that our ancestors to whom Newton alluded did not know, but we have not realized them because economic power is in the hands of a few people, who regardless of political colors, slow down global and democratic development. The crisis of the global transportation industry is the most evident fact. It is necessary to change the global energy system, even for transportation, but the world's ruling class does not want radical changes, which would change the entire world economy.

## **Conclusions**

As demonstrated in SPAWHE's nursery rhyme, compressed hydro-electromagnetic energy could allow us to solve both the problem of global warming, and that of the unequal distribution of world wealth, and that of prolonging human life, and that of being able to add together the thrust of Newton and Lorentz to revolutionize land, sea and space transportation without fuels and energy. Here is spawhe's nursery rhyme <https://www.spawhe.eu>.

"The cleaning of fossil energy published in <https://www.spawhe.eu>, to be efficient, should be based, above all on inorganic chemistry that is able to absorb CO<sub>2</sub>, producing carbonates in the water, so that they counteract the acidification of the oceans and global warming. To speed up the processes and reduce the energy costs that would have involved the circulation of very large quantities of water necessary to neutralize the very large quantities of CO<sub>2</sub> emitted by the current thermal power plants and heat engines,

it has gradually been transformed technologically into solutions of less space by exploiting the principles Pascal and Henry. In fact, I realized that on planet Earth, all the activities that nature produces through organic and inorganic chemistry, photosynthesis and the carbon cycle can be increased in speed without any need to use thermal, nuclear energy and current renewables. It is sufficient only to increase the operating pressures of the systems, modify the circulation pumps and make the machines work differently. In fact, natural interactive systems expel, with the times required by nature, the elements extraneous to natural cycles, due to accidental polluting phenomena, including direct and indirect thermal effects due to volcanic explosions, to natural fires that have always existed on the planet. The current industrial activities of men have multiplied exponentially the elements extraneous to natural cycles, therefore nature is no longer able to restore interactive balances. Obviously, this is my truth and in the entire website, I explain how, in my opinion, we should have created global plants that purify both fumes and water at the same time before they go to pollute the soils, rivers, lakes and seas. Having not done this in any country in the world, it has not been possible to advance the state of the art of purification to make it known to other countries. Therefore, the advancement of the state of the global purification art has not occurred. Consequently, it was not even possible to notice that the water circulation pumps, if we make them work in the direction of gravitational force, by placing them in series with the turbines, we could extract the energy directly from the environment. Having not done this, it was not possible to realize that the water circulation pumps, if in addition to making them pump in the direction of gravitational force, we modify them on the suction side and make them another inlet clearly separated from the main one up to the same impeller, we can always use the same water to create energy because we use one feed to recycle the water from the upper basin and the other feed to introduce into the same

impeller the water discharged from a turbine fed by falling water from the same upper basin. Not having done this, it was not possible to think that by replacing the upper basin with a pressurized autoclave with compressed air, it being understood that we use a turbine connected to the outlet of the autoclave, we can recover the water drained from the turbine and insert it back into the autoclave, whose pressurized water is recycled with the same impeller of the pump by means of the second supply. In this way, with the same water and the same compressed air, we would have produced a current generator that extracts energy from the environment, with quite small dimensions. Having not done this, it was not possible to further reduce the dimensions of this current generator by increasing the operating pressure of the autoclave in order to be able to mount it on cars and trucks, on agricultural tractors. Not having done this, it was not possible to think that the overall dimensions can still be reduced by using submersible pumps as turbines mounted directly in cylindrical tubes that would act as autoclaves. Therefore, these groups could be used to be inserted directly into the wells to raise the water and at the same time oxygenate the aquifers which today are polluted by agricultural fertilizers, herbicides and pesticides and fecal coliforms. In fact, we know that part of the air that pressurizes the autoclave dissolves in the water according to Henry's principle, purifying the water for free. Not having done this, it was not possible to think that the overall dimensions could be reduced even further. Even miniaturized and instead of purifying the water from the wells we could purify the human blood, placing two small autoclaves side by side that would replace the right and left ventricles, creating energetically autonomous artificial hearts that would feed the systemic circuit that oxygenates the brain and the lungs to lengthen the life of the 'man. Having not done this, it was not possible to think that pressurized cylindrical autoclaves can be incorporated an external cylinders containing water at atmospheric pressure, outside of which sliding tracks of permanent magnets mounted on transmission

chains driven by motors can be made electric at variable revolutions that would produce an electromagnetic flux of variable intensity which would produce induced currents in a solenoid outside the same water tank. Therefore, we could produce in this tank a linear electromagnetic thrust force according to Lorentz's law at the ambient temperature, without fuel that could be added to the reaction thrust of Newton that would be produced by propellers driven by electric motors always commanded by generators. of current that produce the primary hydroelectric energy, fed by submersible pumps used as turbines placed inside the central reservoirs. Not having done this, it was not possible to replace the current thermal turbofans of aircraft to travel in the atmosphere and in space with energy extracted directly from the environment, it was not possible to create flying cars, nor submarines that move with the same system without fuel. It was not possible to make the ships travel without fuel, nor to mount the same system to make mobile barriers in the sea to defend ourselves from high waters. It was not even possible to think that in the space travel of the future we can add to the global linear motors an external steel tunnel connected to the turbo fan, where it will produce a higher vacuum higher than the surrounding space vacuum and connect this tunnel with a small vacuum pump to a thickening tank of the captured powders, which will be emptied periodically letting in the atmospheric air which will feed an electrostatic filter that will recover the powders that will be used together with the other interactive purification and energy plant inventions described on the website <https://www.spawhe.eu> to make humans survive even in space without suffering physiological damage due to the absence of atmospheric pressure, gravity, food resources and raw materials to build spare parts for the machines necessary for survival in space. In fact, atmospheric air and water will fill the space caravan wagons full of human beings and will be endlessly recycled, suitably replenished with artificial photosynthesis and carbon cycle, while general gravity will be reinforced, becoming very similar. to the



terrestrial one, electrostatically polarizing the paths of atmospheric conditioned air and recycled water in the interactive, energy and purification, compressed hydroelectromagnetic plants, still unknown to terrestrial science. Current science has forgotten that the primary fluid dynamic energy is produced by the flow rate for the pressure and density of the fluid itself. Therefore, the best solution to produce clean energy at low cost and in infinite quantities is: to use compressed air as an energy source (which is not consumed) and water as an energy carrier (which with the use of new pumps with separate double power supply up to the impeller, can recycle it indefinitely by exploiting the maximum pressure of the compressed air and the maximum density of the water at the same time. In the simple formula of fluid dynamic energy mentioned above. No heat source is needed. This is the biggest mistake in world science because water is not only the best physical and hydraulic energy carrier, it is also the best electromagnetic carrier, having the natural ability to ionize into ions (H+) and (OH-). This ability was given to her directly by nature, that is, by GOD. Excluding water from energy production means excluding physical, chemical, biological and neurological life, above all, producing energy coldly. So much so that among the inventions of the undersigned, there is also the artificial heart which oxygenates human blood, which could extend human life by several hundred years. Obviously, together with other parallel inventions in the field of medicine, robotics, artificial intelligence, which are still to be developed. But air and water, which are fundamental, are provided free by Nature and the artificial heart, at least as a project, is provided free by the undersigned, who has not found financiers. I believe that the artificial heart that oxygenates the blood was not financed by the current ruling class because, if it works, it demonstrates that men have made mistakes in the most important inventions for the survival of nature and the human race, just to accumulate money."

The SPAWHE nursery rhyme, published above, to be fully understood must be read together with the map of the website <https://www.spawhe.eu>, where the inventions of the undersigned and the illustrative articles are published chronologically, starting from the cleaning of fossil energy, as if this had been created, at least with demonstrative prototypes of the functioning. Instead, no one financed these prototypes, but the studies and research I carried out made me understand the limits of this solution, which in order to become sustainable, would have had to reduce the energy costs to raise the water, modify the current purifiers and the prehistoric smokestacks. If one follows the chronology of the inventions and the subsequent articles, it can be noted that the development of the scientific and technological details developed for the cleaning of fossil energy were essential and preparatory to the birth of compressed hydroelectric and hydroelectromagnetic energy, which was born above all to economize the energy consumption necessary to raise the waters and create artificial rains on calcareous materials which would have absorbed the CO<sub>2</sub> and produced alkaline waters. The leap in quality occurred when the undersigned invented the pump with separate dual power supply up to the impeller. In fact, pumps are the heart of all man-made plants and must work with balanced suction and delivery pressures to extract energy from the environment without using fuel to produce primary energy. Therefore, these pumps must have only one impeller and two separate feeds all the way into the impeller to exit with the higher pressure absorbed from the higher pressure source and to be recycled indefinitely. Obviously, working with balanced suction and delivery pressures, heat is no longer necessary to have a pressure that can be exploited statically: it is sufficient to exploit the static pressure of the upper basin or that of an autoclave by recycling the same amount of water that we will use to produce energy so as not to consume the energy required to restore the compressed air pressure. Obviously, pumps with separate dual power supplies cannot produce a driving force greater than that which circulates the

water in the recycling circuit. To produce the driving force we must use the turbines, or pumps fed in reverse compared to the current use, which can have several impellers connected in series to multiply the pressure and therefore the force to be transmitted to the axis of rotation, consuming the energy kinetics acquired thanks to the upper hydrostatic head or to the pressure of the autoclave. Obviously, in order to have a constant energy production we must not lower the level of the upper basin which gives the greater pressure nor lower the pressure of the autoclave. Therefore, conceptually, to extract energy and driving force from the environment it is always necessary to assemble in series a pump with the dual power supply separated up to the impeller and a pump and a turbine or a pump used as a turbine which produces the driving force. We cannot get more water out of the circuit with higher pressure than we use to produce electricity through the current generator connected to the turbine or to the pump used as a turbine. However this system is sufficient to revolutionize all the world's energy and purification systems, since we can produce open plants of any size or pressurized plants at very high pressures in mobile plants without producing pollution and without using fuels and nuclear energy which produce pollution and greenhouse gases such as CO<sub>2</sub> and steam. Steam is still underestimated by world science because it is made up of simple water with neutral pH, while CO<sub>2</sub> combines with water to produce carbonic acid (H<sub>2</sub>CO<sub>3</sub>) which contributes to acidifying lakes and seas. Science has underestimated the fact that CO<sub>2</sub>, despite the strong increase with the production of fossil energy, is still 420 ppm compared to the volume of the atmosphere; The density of CO<sub>2</sub> is only 1.5 times higher than air. Instead, steam, with industrial development and the current way of producing energy with thermal and nuclear plants, has assumed very high percentages, which can even exceed 6% of the volume of the atmosphere, while the density of the drops of water contained in vapor is 830 times higher than atmospheric air. Considering that the force expressed by atmospheric disturbances is

calculated by multiplying the speed by the density of the fluid and the flow rate that moves in the atmosphere, the damage produced by the excess vapor present in the atmosphere is immensely greater than that produced by CO<sub>2</sub>. Scientists who study physics should have been the first to discard the energies that produce steam first and then CO<sub>2</sub>, which is always combined with other combustion gases that are also toxic (SO<sub>x</sub>, NO<sub>x</sub>, CO, etc). Furthermore, considering that scientists who have studied meteorological phenomena from the beginning of the 1900s until now have ascertained that between the earth's surface and the ionosphere there is a continuous exchange of electrostatic and electromagnetic ions which is continuously regenerated through the production of electric discharges commonly called lightning, in the immense quantity of approximately 1500 -2000 for every second on the entire terrestrial globe, for at least a hundred years we should have realized that it was necessary to look for a different way of producing electricity, avoiding the production of steam and CO<sub>2</sub>, but also to avoid the transport of electrical energy in the atmosphere, which inevitably interferes with the natural ion exchange between the earth and the ionosphere. Unfortunately, the entire world of science, not having understood these fundamental scientific and technical concepts, has allowed the rush to use the wrong energy sources which have needlessly wasted natural resources and created global warming. The SPAWHE nursery rhyme is nothing more than a long list of sustainable inventions proposed by the undersigned and not financed by governments and world entrepreneurs due to the silence of the science most awarded with Nobel prizes, which today is trying to create the new nuclear power on Earth, based on nuclear fusion involving temperatures of 100 million degrees centigrade that would be magnetically isolated with technologies yet to be tested. While the Creator of the universe preferred to create the nuclear energy of the stars at a distance of hundreds of millions of kilometers from the planets and protected the planets themselves by different atmospheric layers thickened

by the gravitational force, while the nuclear energy produced inside the nuclei ferromagnetic elements of the same planets is isolated by different layers of the subsurface. Furthermore, the Creator of the universe made it possible to develop through the gravitational force, universal electromagnetism, an ionic exchange between atmospheric air, water, organic and inorganic materials, the production of invisible electrical energy that governs the planet without no need for special energy transport lines. In fact, electrical and electromagnetic energy is already present on the planet. Therefore, the SPAWHE system is nothing other than the natural terrestrial energy system put together by the undersigned using scientific principles and the inventions of the past put together more rationally from an industrial point of view and set based on his own experience as a former designer and installer of anthropic systems terrestrials. However, with the plants planned on SPAWHE we could increase global food production with artificial welling, bring water to deserts by desalination of sea water in a sustainable way, but first of all, it is essential to demolish the wrong inventions and build the correct ones but the entire world ruling class pretends not to understand and talks nonsense about renewable energy. The solution is much simpler, linear and economical and can be applied everywhere even in the human heart to extend human life. It is no coincidence that none of the logical inventions, chronologically conceived, have ever been tested and implemented. As long as they remain only in the virtual state, it can always be said that it is only simple science fiction. Instead, for the undersigned it is science fiction that must be based on simple but well-connected inventions, such as global linear motors that could also take us into space without fuels and nuclear energy, even capturing interstellar dust to increase food resources and technologies of generational travellers, mostly equipped with energetically autonomous blood oxygenating artificial hearts. . I also publish below the website map, of unrealized inventions, with this article updated as of 25.12.2024. Exactly 2024 years

after the birth of the son of the creator of the universe.

**Website map <https://www.spawhe.eu>**

<https://www.spawhe.eu/permanent-open-letter-to-ordinary-people-to-explain-spawhes-inventions-in-the-time-of-the-unequal-distribution-of-wealth-global-warming-and-coronaviruses/>,

**<https://www.spawhe.eu/about-me/> and about spawhe**

*The nursery rhyme of Spawhe, the website map and the mysterious silences of world science.*

**123) 27.11.2024**

**[https://www.spawhe.eu/cop29-and-g20-2024-the-conspiracy-of-the-powerful-against-sustainable-development/;](https://www.spawhe.eu/cop29-and-g20-2024-the-conspiracy-of-the-powerful-against-sustainable-development/)**

**122) 07.11.2024**

**[https://www.spawhe.eu/the-spawhe-system-can-save-planet-earth-from-global-warming-floods-droughts-and-fires/;](https://www.spawhe.eu/the-spawhe-system-can-save-planet-earth-from-global-warming-floods-droughts-and-fires/)**

**121) 05.10.2024**

**[https://www.spawhe.eu/the-difference-between-the-energy-of-the-universe-and-that-of-planet-earth/;](https://www.spawhe.eu/the-difference-between-the-energy-of-the-universe-and-that-of-planet-earth/)**

**120) 17.09.2024**

**[https://www.spawhe.eu/third-open-letter-to-un-secretary-general-antonio-guterres-on-the-occasion-of-the-upcoming-future-summit/;](https://www.spawhe.eu/third-open-letter-to-un-secretary-general-antonio-guterres-on-the-occasion-of-the-upcoming-future-summit/)**

**119) 28.07.2024**

**[https://www.spawhe.eu/global-environmental-and-energy-fundraising-must-be-called-spawhe/;](https://www.spawhe.eu/global-environmental-and-energy-fundraising-must-be-called-spawhe/)**

**118) 03.07.2024**

**<https://www.spawhe.eu/sorry-for-the-delay-for-the-hopefully-definitive-clarification-of-some-aspects-of-terrestrial-energy;>**

**117) 28.06.2024**

[https://www.spawhe.eu/the-future-of-terrestrial-common-sense-is-called-submerged-compressed-and-reinforced-hydroelectric-energy-without-the-hydraulic-jump/;](https://www.spawhe.eu/the-future-of-terrestrial-common-sense-is-called-submerged-compressed-and-reinforced-hydroelectric-energy-without-the-hydraulic-jump/)

**116)** **20.06.2024**

[https://www.spawhe.eu/the-causes-the-culprits-and-spawhes-solution-against-global-warming-second-open-letter-to-the-real-un-secretary-antonio-guterres/;](https://www.spawhe.eu/the-causes-the-culprits-and-spawhes-solution-against-global-warming-second-open-letter-to-the-real-un-secretary-antonio-guterres/)

**115)** **26.05.2024**

[https://www.spawhe.eu/the-possible-and-scientific-neutralization-of-global-warming-with-the-energy-and-purification-cycle-of-water/;](https://www.spawhe.eu/the-possible-and-scientific-neutralization-of-global-warming-with-the-energy-and-purification-cycle-of-water/)

**114)** **20.04.2024**

[https://www.spawhe.eu/lets-talk-scientifically-about-the-italian-disaster-of-the-bargi-hydroelectric-power-plant/;](https://www.spawhe.eu/lets-talk-scientifically-about-the-italian-disaster-of-the-bargi-hydroelectric-power-plant/)

**113)** **15.02.2024**

[https://www.spawhe.eu/it/lets-talk-about-the-scientific-reasons-for-the-protests-of-european-farmers-that-science-and-governments-hide/;](https://www.spawhe.eu/it/lets-talk-about-the-scientific-reasons-for-the-protests-of-european-farmers-that-science-and-governments-hide/)

**112)** **07.01.2024**

[https://www.spawhe.eu/open-letter-to-sir-leonard-valentinovich-blavatnik-for-information-to-mr-bill-gates-and-mr-elon-musk-regarding-environment-and-energy/;](https://www.spawhe.eu/open-letter-to-sir-leonard-valentinovich-blavatnik-for-information-to-mr-bill-gates-and-mr-elon-musk-regarding-environment-and-energy/)

**111)** **19.12.2023**

[https://www.spawhe.eu/cop-28-science-has-not-understood-that-planet-earth-could-be-energetically-autonomous-without-fossil-fuels-and-nucleated-energy/;](https://www.spawhe.eu/cop-28-science-has-not-understood-that-planet-earth-could-be-energetically-autonomous-without-fossil-fuels-and-nucleated-energy/)

**110)** **26.11.2023**

[https://www.spawhe.eu/cop-28-the-usual-conference-of-global-scientific-hypocrisy-like-the-twenty-seven-previous-cops/;](https://www.spawhe.eu/cop-28-the-usual-conference-of-global-scientific-hypocrisy-like-the-twenty-seven-previous-cops/)

**109)** **03.11.2023**

<https://www.spawhe.eu/from-the-theory-of-general-relativity-to>

-the-general-artificial-terrestrial-interactivity-unwanted-by-governments-and-multinationals/,

108) 03. 09 2023

<https://www.spawhe.eu/world-governments-that-reject-the-extraction-of-clean-energy-from-the-environment-reject-a-perennial-scientific-windfall-from-the-sky/>,

107) 21.06.2023

<https://www.spawhe.eu/the-scientifically-disorganized-work-of-public-bodies-and-multinationals-of-planet-earth/>,

106) 24. 05. 2023

<https://www.spawhe.eu/lets-talk-about-the-responsibilities-of-floods-and-other-even-more-serious-responsibilities/>

105) 12.05.2023

<https://www.spawhe.eu/flying-containers-for-rescuing-migrants-and-extinguishing-fires-without-using-fuel/>,

104) 25.01.2023,

<https://www.spawhe.eu/science-and-politics-do-not-know-terrestrial-physics-and-the-scientific-organization-of-work/>,

103) 05.11. 2022

<https://www.spawhe.eu/cop-27-open-letter-to-deputies-senators-world-information-bodies-on-the-subject-of-the-environment-and-energy/>,

102) 10.10.2022

<https://www.spawhe.eu/open-letter-to-the-new-italian-prime-minister-giorgia-meloni-on-the-subject-of-environment-and-energy/>;

101) 28.08. 2022

<https://www.spawhe.eu/year-2022-record-of-heat-drought-storms-indomitable-fires-economic-inflation/>;

100) 10.05.2022

<https://www.spawhe.eu/year-2022-the-war-in-ukraine-was-added-t>



**o-covid-19-to-the-inexistence-of-interactive-physical-defenses-suitable-for-the-environment-and-the-human-body/;**

**99) 14.04.2022**

**<https://www.spawhe.eu/the-crime-of-omission-of-the-world-public-institutions-in-matters-of-the-environment-energy-and-health-which-favors-multinationals-synthesized-in-the-nursery-rhymes-of-spawhe-eu/>**

**98) 26.03.2022**

**<https://www.spawhe.eu/the-politics-of-terror-and-irrational-energy-of-nato-russia-and-china/>**

**97) 19.02.2022**

**<https://www.spawhe.eu/from-black-holes-to-the-uncertainty-principle-to-the-scientific-organization-of-work-unknown-by-science-and-by-the-authorities-on-earth/>**

**96) 27.11. 2021**

**<https://www.spawhe.eu/fundraising-in-defense-of-life-according-to-the-spawhe-model/>**

**<https://www.spawhe.eu/raccolta-fondi-in-difesa-della-vita-secondo-il-modello-spawhe/>**

**95) 13.11. 2021**

**<https://www.spawhe.eu/the-g20s-and-cop2627-cannot-understand-what-science-has-not-yet-understood/>**

**<https://www.spawhe.eu/i-g20-e-le-cop2627non-possono-comprendere-quello-che-la-scienza-non-ha-ancora-compreso/>**

**94) 01.11.2021**

**<https://www.spawhe.eu/g20-of-the-year-2021-the-conference-of-who-should-save-the-planet-earth-by-immediately-starting-the-interactive-ecological-transition/>**

**93) 26.09.2021**

**<https://www.spawhe.eu/what-world-science-has-not-understood-is-the-difference-between-the-universal-primary-energy-and-the-terrestrial-one/>**

92)

14.09.2021

<https://www.spawhe.eu/the-worldwide-misunderstanding-of-perpetual-motion-that-has-affected-terrestrial-development-and-space-research/>,

91)

29.07.2021 <https://www.spawhe.eu/from-the-earth-beyond-the-moon-colonizing-space-with-compressed-hydroelectromagnetic-energy-unknown-to-terrestrial-science/>,

90)

29.07.2021 <https://www.spawhe.eu/interstellar-dust-capture-system-and-space-environmental-plants/>, <https://www.spawhe.eu/sistema-di-cattura-polveri-interstellari-e-impianti-ambientali-spaziali/>

89)

22.02.

2021 <https://www.spawhe.eu/open-letter-accompanying-the-open-letter-to-the-new-president-of-the-italian-council/>,

88)

12.02.

2021 <https://www.spawhe.eu/open-letter-to-the-new-prime-minister-of-the-italian-government-mario-draghi-in-the-field-of-environment-energy-and-public-health/>,

87)

01.02.

2021 <https://www.spawhe.eu/open-letter-to-mr-elon-musk-who-promised-100-million-dollars-to-those-who-manage-to-capture-co2-from-the-atmosphere/>,

86)

15.01.2021 <http://www.spawhe.eu/how-you-can-live-most-of-the-human-body-a-well-fed-and-well-oxygenated-brain-technological-scientific-system-of-survival-against-disease-disability-and-old-age/>,

85)

27.10.

**2020 <http://www.spawhe.eu/where-science-does-not-reach-the-scientific-organization-of-work-arrives-if-it-is-applied-globally/>,**

**84) 28. 10.**

**2020 <http://www.spawhe.eu/the-great-gap-between-the-science-of-god-and-that-of-man-that-produced-global-warming-and-covid-19/>,**

**83)23.09.2020 <http://www.spawhe.eu/the-greatest-crimes-against-humanity/>,**

**82)20.09.2020 <http://www.spawhe.eu/what-are-the-world-parliamentarians-for/>,**

**81)14.062020 <http://www.spawhe.eu/a-small-italian-miracle-of-giuseppe-contes-government/>,**

**80)17.06.2020 <http://www.spawhe.eu/in-which-virtual-dimension-live-politicians-scientists-and-economists-who-do-not-know-the-terrestrial-reality/>,**

**79)  
20.05.2020 <http://www.spawhe.eu/open-letter-to-worldwide-publishers-in-the-time-of-covid-19/>,**

**78)  
28.04.2020 <http://www.spawhe.eu/no-unknown-viruses-will-kill-us-if-we-modify-mans-defenses/>,**

**77)  
23.04.2020 <http://www.spawhe.eu/covid-19-and-the-world-bag-losses-are-due-to-the-unknown-principle-of-body-impenetrability/>,**

**76)  
11.03.2020 <http://www.spawhe.eu/open-letter-to-the-patent-office-and-the-italian-government-in-the-time-of-the-coronavirus/>,**

**75)**

28.02.2020 <http://www.spawhe.eu/a-global-stock-company-against-errors-omissions-and-opportunities-wasted-by-science-and-world-power-centers/>,

74)

31.01.2020 <http://www.spawhe.eu/flying-and-floating-cars-with-interactive-global-linear-motors-and-thrust-of-newton-and-lorentz/>,

73)

31.01.2020 <http://www.spawhe.eu/aerospace-and-submarine-transport-system-with-interactive-primary-and-inductive-linear-motors/>,

72)19.12.2019 <http://www.spawhe.eu/against-the-inefficiency-of-the-united-nations-and-governments-even-the-obed-of-widow-may-be-useful-to-protect-the-environment/>,

71)

16.09.2019 <http://www.spawhe.eu/environmental-projects-and-replies-of-a-false-general-secretary-of-the-un/>,

70)

3.09.2019 <http://www.spawhe.eu/the-global-warming-has-been-produced-legally/>, h

69)30.05.2019 <http://www.spawhe.eu/the-interactive-energy-that-the-current-generations-do-not-understand-are-the-best-resource-of-future-generation/>,

68)

15.04.2019 <http://www.spawhe.eu/the-omission-crime-is-the-daily-bread-of-sciences-bureaucrats-and-world-governments/>,

67)

11.03.2019 <http://www.spawhe.eu/hydroelectric-greenhouses-for-the-purification-of-fumes-co2-and-water-with-natural-alkalinisation/>,

66)25.01.2019 <http://www.spawhe.eu/cop24-the-replies-that-miss>

**- to-greta-thunberg-yellow-gilets-poor-countries-and-sustainable-inventions/,**

**65)10.12.2018 <http://www.spawhe.eu/someone-in-the-world-should-prohibit-the-incomplete-inventions-of-science/>,**

**64)**

**30.08.2018 <http://www.spawhe.eu/development-and-the-environment-penalized-by-science-and-international-laws/>,**

**63)**

**18.08.2018 <http://www.spawhe.eu/who-govern-the-world-the-sovereign-states-or-the-world-bag/>,**

**62)**

**11.06.2018 , <http://www.spawhe.eu/the-world-public-debt-fraud/>**

**61)**

**31.05.2018 <http://www.spawhe.eu/artificial-heart-oxygenator-of-blood-energetically-autonomous/>,**

**60)30.05.2018 <http://www.spawhe.eu/sustainable-environmental-design-is-a-social-duty-of-world-institutions-mini-domestic-water-purification-system-with-hydroelectric-energy-production/>,**

**59)30.05.2018 <http://www.spawhe.eu/the-european-social-innovation-competition-lottery/>,**

**58)**

**02.04.2018 <http://www.spawhe.eu/the-world-needs-political-scientists-and-judges-more-close-to-people-and-environment/>,**

**57)**

**04.03.2018 <http://www.spawhe.eu/pct-it2016-000202-open-letter-to-w-i-p-o-and-the-international-legal-offices/>,**

**56)**

**01.03.2018 <http://www.spawhe.eu/we-integrate-the-principles-of-energy-conservation-to-correct-the-serious-errors-of->**

science/,

55)

19.02.2018 <http://www.spawhe.eu/the-lost-civilizations-einsteins-thought-and-survival-energy/>,

54)

29.12.2017 <http://www.spawhe.eu/compressed-air-is-much-more-powerful-practice-and-economic-of-hydrogen/>,

53)

07.12.2017 <http://www.spawhe.eu/after-the-failure-of-cop23-it-is-needful-to-realize-prototypes-of-interactive-energy-before-cop24/>,

52)30.11.2017 <http://www.spawhe.eu/cop23-the-unthinkable-has-already-been-thought-with-interactive-energy/>,

51)10.11.2017 <http://www.spawhe.eu/cop-23-the-mysteries-of-the-interactive-energy-and-depurations-hided-by-the-institutions/>, <http://www.spawhe.eu/it/cop-23-i-misteri-dellenergie-e-delle-depurazioni-interattive-occultate-dalle-istituzioni/>

50)31.10.2017 <http://www.spawhe.eu/the-force-of-rational-scientific-global-reasoning-made-instant-by-instant/>, <http://www.spawhe.eu/it/la-forza-del-ragionamento-razionale-scientifico-globale-fatto-istante-per-istante/>

49)30.10.2017 <http://www.spawhe.eu/a-new-development-model-with-interactive-energy-and-rich-floating-camps-built-in-oceans-with-petroleum-derivates/>,

48)30.09.2017 <http://www.spawhe.eu/the-world-revolution-of-transportation-unwanted-by-manufacturers-by-science-by-the-governments-and-others/>,

47)

30.09.2017 <http://www.spawhe.eu/archimedes-was-wrong-but-the-science-has-never-correct-him/>,

46)04.09.2017 <http://www.spawhe.eu/the-interactive-energy-inexhaustible-and-protective-of-the-environment-unwanted-by-science-and-governments/>,

45)20.08.2017 <http://www.spawhe.eu/if-science-was-been-globally-applied-current-energies-and-depurations-would-not-have-a-future/>,

44)04.08.2017 <http://www.spawhe.eu/learn-to-extract-better-energy-from-the-environment/>,

43)31.07.2017 <http://www.spawhe.eu/aerospatial-pressurized-hydroelectric-transport-system-with-turbofan-and-compressed-air-injection/>,

42)13.02.2017 <http://www.spawhe.eu/the-hoax-of-the-fight-against-global-warming/>,

41)13.02.2017 <http://www.spawhe.eu/defend-the-environment-and-territory-from-floods-by-producing-energy/>,

40)10.02.2017 <http://www.spawhe.eu/the-fossil-energy-that-pollute-costs-more-of-clean-energy/>,

39)14.01.2017 <http://www.spawhe.eu/hydroelectric-power-auto-with-peripheral-torque-to-the-wheels/>,

38)04.01.2017 <http://www.spawhe.eu/fighting-global-warming-extending-the-borders-of-perpetual-motion/>,

37)15.12.2016 <http://www.spawhe.eu/pressurized-domestic-hydraulic-system-producer-of-hydroelectric-energy/>,

36)

25.11.2016 <http://www.spawhe.eu/cop22-failed-international-crime-of-states-not-punished-when-the-collapse-of-worldwide-economy/>,

35)15.11.2016 <http://www.spawhe.eu/marrakech-2016-is-there-a-conspiracy-or-is-only-scientific-technological-political->

legislative-incompetence-which-increases-the-co2-in-the-environment/ ,

34 )

11.11.2016 <http://www.spawhe.eu/pressurised-submerged-hydroelectric-plants-in-wells-with-lifting-and-oxygenation/> ,

33)10.11.2016 <http://www.spawhe.eu/pressurised-submerged-hydroelectric-plants-in-basins-with-lifting-and-oxygenation/> ,

32 )

31.08.2016 <http://www.spawhe.eu/pumps-and-turbines-with-separated-double-supply-until-to-the-impeller/> ,

31)22.07.2016 <http://www.spawhe.eu/relativity-and-technology-in-the-new-hydroelectric-energy/> ,

30 )

11.07.2016 <http://www.spawhe.eu/the-sustainable-future-of-environment-energy-food-and-labour-is-based-on-the-new-hydrology/> ,

29)30.06.2016 <http://www.spawhe.eu/autoclave-system-for-water-pumping-hydroelectric-energy-producer/> ,

28)10.06.2016 <http://www.spawhe.eu/floating-system-with-extruded-polyethylene-pipes-ribbed-reinforced-and-filled-with-polystyrene/> ,

27 )

10.06.2016 <http://www.spawhe.eu/floating-system-hydroelectric-desalter-extractor-of-calcium-and-carbon-from-marine-deep-water/> ,

26 )

10.06.2016 <http://www.spawhe.eu/vertical-desalinators-demineralizers-by-ion-exchange-with-hydroelectric-energy-production/> ,

25)15.04.2016 <http://www.spawhe.eu/where-is-the-science-and-where-hope/> ,



- 24)10.06.2016 <http://www.spawhe.eu/open-letter-to-mr-bill-gates-on-energy-miracle/>,
- 23 )  
09.12.2015 <http://www.spawhe.eu/the-future-of-energy-is-hydroelectric-but-not-the-present-hydro-power/>,
- 22)05.12.2015 <http://www.spawhe.eu/the-causes-of-the-failure-of-the-world-summit-in-paris/> ,
- 21 )  
30.11.2015 <http://www.spawhe.eu/the-water-and-energy-revolution-in-eight-global-projects-to-cool-the-planet-create-eating-and-work-2/>,
- 20)16.11.2015 <http://www.spawhe.eu/from-efficient-purification-to-sustainable-energy/>,
- 19)31.10.2015 <http://www.spawhe.eu/the-probable-reasons-for-the-lack-protection-of-the-environment/>,
- 18 )  
16.10.2015 <http://www.spawhe.eu/global-synergy-plants-for-depuratation-biomass-production-and-thermoelectric-cogeneration-gspdptc/>,
- 17)10.09.2015 <http://www.spawhe.eu/hydropower-plants-with-lifting-recycling-and-water-distribution/> ,
- 16)22.06.2015 <http://www.spawhe.eu/open-letter-to-italian-patent-office-and-to-the-minister-of-economic-development/> ,
- 15)15.06.2015 <http://www.spawhe.eu/also-churches-and-associations-should-learn-to-design/> ,
- 14)11.06.2015 <http://www.spawhe.eu/energy-right-at-the-right-time-in-the-right-place-2/>,
- 13)03.06.2015 <http://www.spawhe.eu/second-open-letter-to-the-european-commission/> ,

- 12) 10.05.2015 <http://www.spawhe.eu/appeal-for-spawhe-on-the-occasion-of-expo-2015/> ,
- 11) 05.04.2015 <http://www.spawhe.eu/last-appeal-for-spawhe-before-the-expiration-of-international-patents/> ,
- 10) 16.12.2014 <http://www.spawhe.eu/it/lettera-aperta-ai-progettisti-e-imprenditori-italiani/>,
- 9)  
30.11.2014 <http://www.spawhe.eu/the-water-and-energy-revolution-in-eight-global-projects-to-cool-the-planet-create-eating-and-work/> ,
- 8) 21.10.2014 <http://www.spawhe.eu/the-perpetual-energetic-motion-is-possible-in-the-fixed-and-mobile-versions/>, <http://www.spawhe.eu/it/il-moto-perpetuo-energetico-e-possibile-nelle-versioni-fisse-e-mobili/>
- 7)  
04.07.2014 <http://www.spawhe.eu/capture-cooling-purification-chimneys-ccpc-international-patent-n-patent-wo2014-076724-and-subsequent-invention-air-filtration-and-thermal-exchange-tower-aftet/> ,
- 6)  
04.07.2014 <https://www.spawhe.eu/vertical-synergic-buildings-vs-for-co2-and-water-depuration-plus-biomass-production/> ,
- 5) 04.07.2014 <http://www.spawhe.eu/linear-synergistic-system-of-digestion-dehydration-and-composting-ldcc/>,
- 4) 04.07.2014 <http://www.spawhe.eu/global-synergy-plants-for-depuration-biomass-production-and-thermoelectric-cogeneration/>,
- 3) 28.02.2013 <http://www.spawhe.eu/closing-the-anthropogenic-carbon-cycle/>,

2)

28.11.

2007 <http://www.spawhe.eu/phosphor-removal-from-detergents-wastewater-and-greywater-recycling-system-for-flushing-toilets/> ,

1) 15.11.2007 <http://www.spawhe.eu/english-curriculum-vitae/> , <http://www.spawhe.eu/it/curriculum-vitae-italiano/>

**Cordiali saluti**

**Luigi Antonio Pezone**

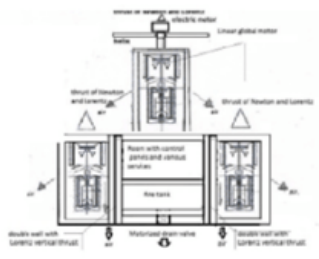
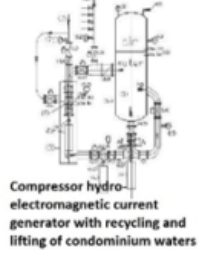
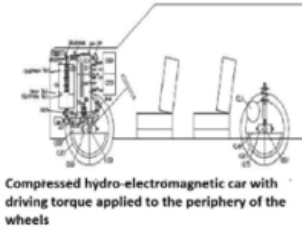
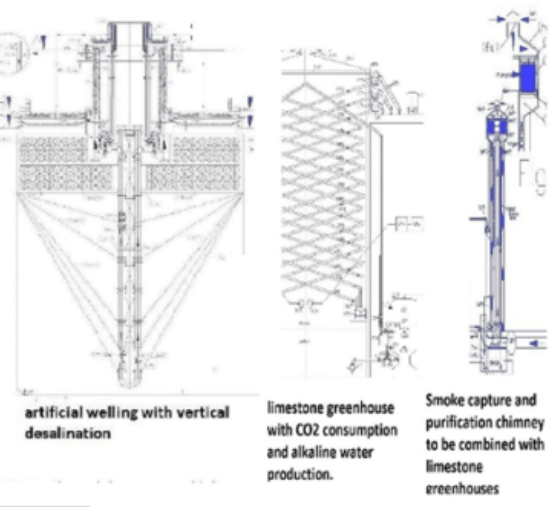
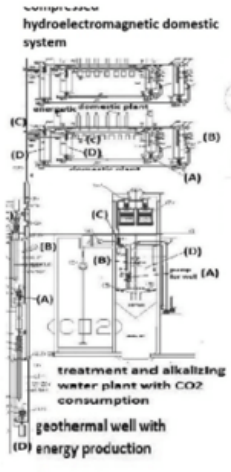
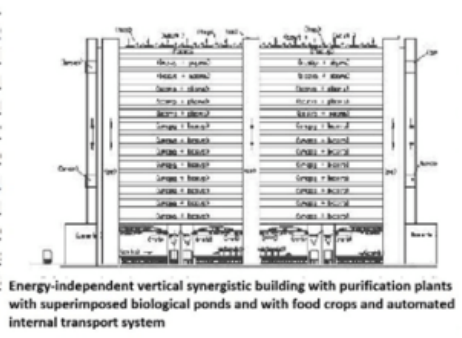
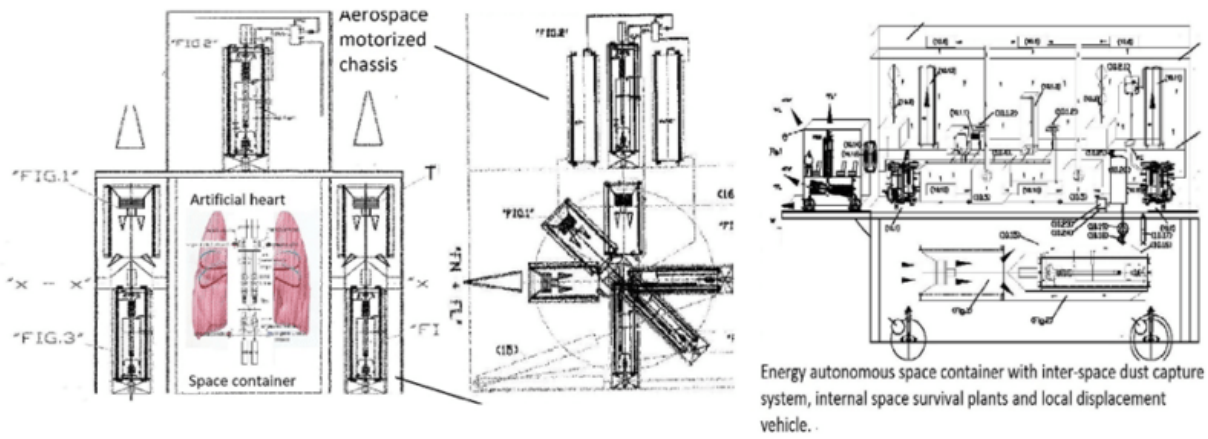

Pressurized fire container with Newton and Lorentz

The principles of inertia and reaction revised and corrected by SPAWHE.eu against thermal, nuclear and electric car follies.  
 The simple and economical way to produce energy, purify and distribute the world's water  
<https://www.spawhe.eu> by luigi antonio pezone